

**Highlights**

- Ready-to-connect flexible LED-strip with High Density and Efficiency – HDE
- Constant Current Driven IC for professional lighting applications
- 144 LEDs per meter – ideal for homogenous lighting at close distances
- Excellent white color consistency MacAdams SDCM ≤3
- High color rendering index CRI > 80
- Perfect for shelf and accent lighting, e.g. slim linear profiles with opal cover
- Reflective white copper PCB for optimal system efficiency
- High quality adhesive 3M-tape on backside for easy mounting on clean surface or cooling profile
- Long lifetime: L70 = 50.000h ①

**Applications**

- Shelf Lighting
- Indirect Lighting
- Cove Lighting
- Accent Lighting

**Electrical Properties**

- Supplied with constant voltage 24 VDC
- Stable photometrics in combination with wide input voltage range 22-26 VDC
- Connect up to 10 meters in series
- Optimized for high resolution dimming 0,1-100% using Tridonic and feno digital drivers controlled via switchDIM, DSI, DALI or DMX.

**Standards**

→ page 2

**Mounting Instructions**

→ page 4

**Accessories/Options**

- Outdoor version IP65 with silicon casing
- Aluminum profiles for linear and corner applications
- Wide variety of lenses and covers 15°/30°/60°/120°/Asymmetric/Batwing
- Fixed or adjustable mounting brackets
- Large selection of drivers and dimmers and control systems to fit every need and application

→ page 7

Type	Article Code	Supply Voltage (VDC) ③	Color (K)	Photometric Code ⑤	Typ. Data per meter ① ②				Pitch Distance (P)	Cutting Length (C)	LxWxH (mm)	Energy Class (EEI)	Operating temp (°C) ④
					Luminous flux (lm)	Current (mA)	Power (W)	LED quantity					
LEDtape 830 700 HDE G2	W1004-830-G2	24	3000	830 / 349	680	360	8,6	144	7 mm	42 mm	5040x10x2	A+	-20 °C +55 °C
LEDtape 830 700 HDE IP65 G2	W1004-830-IP-G2	24	3000	830 / 349	646	360	8,6	144	7 mm	42 mm	5040x14x6	A+	-20 °C +35 °C
LEDtape 840 700 HDE G2	W1004-840-G2	24	4000	840 / 349	720	360	8,6	144	7 mm	42 mm	5040x10x2	A+	-20 °C +55 °C
LEDtape 840 700 HDE IP65 G2	W1004-840-IP-G2	24	4000	840 / 349	684	360	8,6	144	7 mm	42 mm	5040x14x6	A+	-20 °C +35 °C
LEDtape 860 700 HDE G2	W1004-860-G2	24	6000	860 / 349	705	360	8,6	144	7 mm	42 mm	5040x10x2	A+	-20 °C +55 °C
LEDtape 860 700 HDE IP65 G2	W1004-860-IP-G2	24	6000	860 / 349	670	360	8,6	144	7 mm	42 mm	5040x14x6	A+	-20 °C +35 °C
LEDtape 865 700 HDE IP65	W1004-865-IP	24	6500	865 / 349	680	370	8,6	144	7 mm	42 mm	5040x14x6	A+	-20 °C +35 °C

① All values for ta = 25 °C / tc = 65 °C

② Tolerance range for electrical and optical data ±10%

③ Exceeding the maximum operating voltage leads to an overload on the tape. This may result in a significant reduction in lifetime or even destruction of the tape. Tolerance range for the supply voltage 24V: +2V / -2V

④ Self-cooling at ta ≤ 35 °C

⑤ According to IEC 62717

## Standards

- EN 55015
- EN 61547
- EN 62471
- IEC 62717

## Thermal behavior

Storage Temperature	-30/+60 °C
Operating Temperature	-20/+35/+50 °C
Tc max	75 °C

relative luminous flux vs. tc point

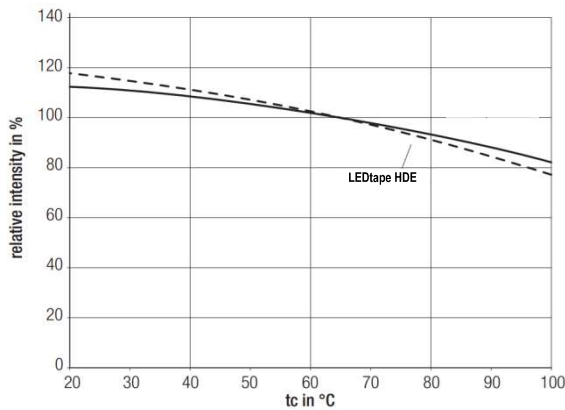

## ⚠ Thermal design and heat sink

The rated life of LED-products depends to a large extent on the temperature. Weilight's excellent thermal design for the LEDtape products provides the lowest thermal resistance and therefore allowing new compact designs without sacrificing quality, safety and life time. However, if the permissible temperature limits are exceeded, the life of the LEDtape will be greatly reduced or the LEDtape may be destroyed.

It might be necessary to mount the LEDtape onto a heat sink, e.g. an aluminum profile. The size of the heat sink is largely depending on the ambient temperature (ta) of the application. The following tables should be seen as a guide to a recommended heat sink depending on different ta:

### LEDtape 700 HDE (per meter)

Ambient Temperature (Ta)	Reference Temperature (Tc)	Cooling Area (cm²)	Thermal Resistance R <sub>thSA</sub>	Recommended Aluminum profile
25 °C	65 °C	Self-cooling	Self-cooling	Optional
35 °C	65 °C	Self-cooling	Self-cooling	Optional
45 °C	65 °C	300	2,1 K/W	Z200-2 / Z201-2 / Z22W-2
55 °C	65 °C	400	1,8 K/W	Z22W-2

### LEDtape 700 HDE IP65 (per meter)

Ambient Temperature (Ta)	Reference Temperature (Tc)	Cooling Area (cm²)	Thermal Resistance R <sub>thSA</sub>	Recommended Aluminum profile
25 °C	65 °C	Self-cooling	Self-cooling	Optional
35 °C	65 °C	Self-cooling	Self-cooling	Optional
45 °C	Not allowed	-	-	-
55 °C	Not allowed	-	-	-

The temperature at tc reference point is crucial for the light output and life time of an LEDtape. For the weilight LEDtape a tc temperature of 65 °C is recommended in order to achieve an optimum between heat sink requirements, light output and life time.

## Life time, lumen maintenance and failure fraction

The light output of the LEDs on the tape decreases over the life-time, this is characterized with the L value. L70 means that the LEDtape will give 70 % of its initial luminous flux. This value is always related to the number of operation hours and therefore defines the lifetime of the LEDs.

The L value is a statistical value and the lumen maintenance may vary over the delivered LEDtapes. The B value defines the amount of LEDs which are below the specific L value, e.g. L70B10 means 10 % of the LEDs are below 70 % of the initial luminous flux, respectively 90 % will be above 70 % of the initial value.

In addition the percentage of failed LEDs (fatal failure) is characterized by the C value. The F value is the combination of the B and C value. That means for F degradation and complete failures are considered, e.g. L70F10 means 10 % of the LEDs on the tape may fail or be below 70 % of the initial luminous flux.

Type	Ambient Temperature (Ta)	L90F10	L70F10
LEDtape 700 HDE	25 °C	35 000 h	55 000 h
	55 °C	26 000 h	35 000 h
LEDtape 700 HDE IP65	25 °C	24 000 h	50 000 h
	35 °C	16 000 h	30 000 h

**NOTE!** The temperature on the surface of the LEDtape (tc) may under no circumstances be higher than 65 °C if the expected lifetime of the LEDtape is to be met. Compliance with the maximum permissible reference temperature at the tc point must be checked under operating conditions in a thermally stable state. The maximum value must be determined under worst-case conditions for the relevant application.

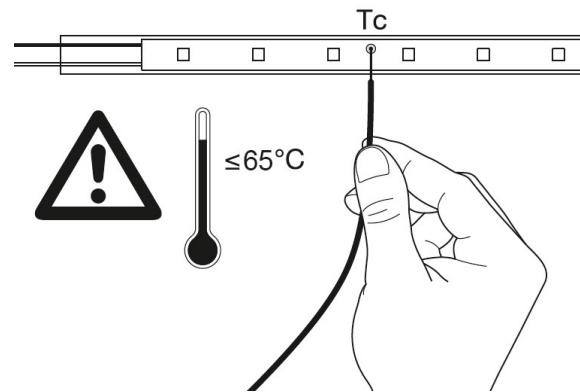

## Light Distribution

Radiance Angle = 120°

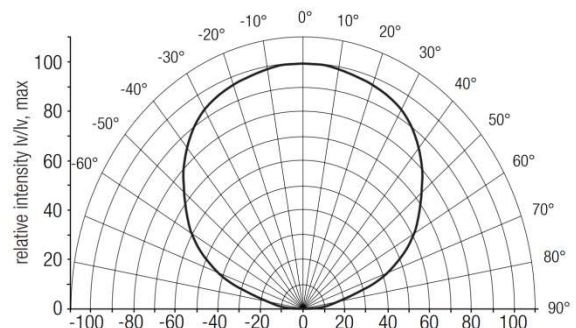

## Photometric Code (according to EN 62717)

1 st digit		2nd + 3rd digit	4th digit	5th digit	6th digit	
Code	CRI	Color temperature in Kelvin x 100	Initial MacAdam ellipse SDCM	Maintained MacAdam ellipse SDCM after 25% of the lifetime (6000 h)	Lumen maintenance after 25% of the lifetime (6000 h)	
7	67 - 76				Code	Light Output
8	77 - 86				7	≥ 70 %
9	87 - ≥90				8	≥ 80 %
					9	≥ 90 %

## Chromaticity coordinates and tolerances (according to CIE 1931)

White Tone	CCT	Photometric Code
Warm	3000 K	830 / 349
Neutral	4000 K	840 / 349
Cool	6000 K	860 / 349

The specified color coordinates are measured by a current impulse with nominal values of module after a settling time of 100 msec. The ambient temperature of the measurement is  $t_a = 25\text{ }^\circ\text{C}$ . The measurement tolerance of the color coordinates are  $\pm 0.01$ .

### 3,000 K

	x0	y0
Centre	0.4300	0.4016

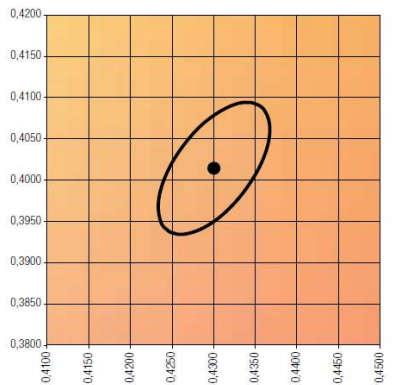

MacAdam ellipse: 3 SDCM

### 4,000 K

	x0	y0
Centre	0.3761	0.3740

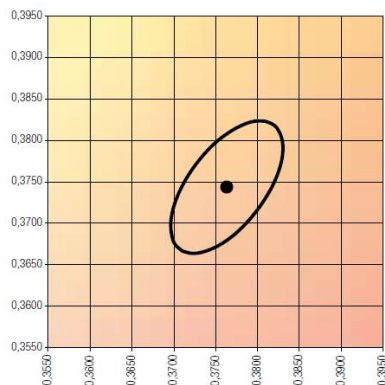

MacAdam ellipse: 3 SDCM

### 6,000 K

	x0	y0
Centre	0,3200	0,3270

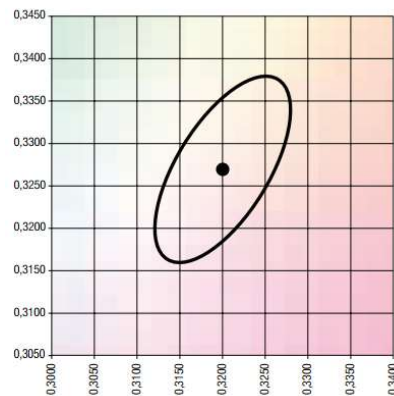

MacAdam ellipse: 3 SDCM

## Mounting Instructions

### Mechanical

The fixing/cooling surface must be properly cleaned to remove grease, dirt and silicon before application, e.g. using Isopropyl alcohol.

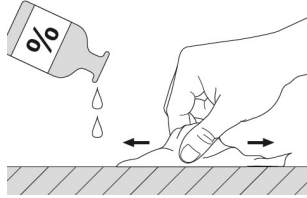

Never bend the LED-tape at a radius smaller than 50 mm. Assembly must not damage or destroy conducting paths on the circuit board.

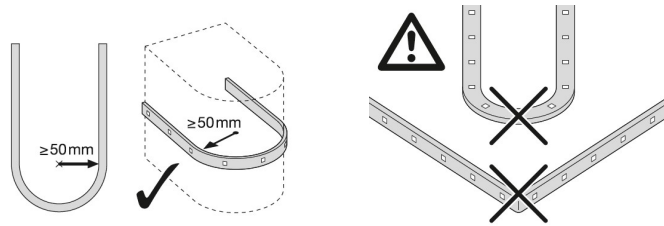

The LED module itself and all its components must not be mechanically stressed. When fixing the LED-tape to a surface, apply an even but gentle pressure and try to avoid applying pressure directly on the LED itself (the maximum allowed pressure is 20 N/cm<sup>2</sup>).

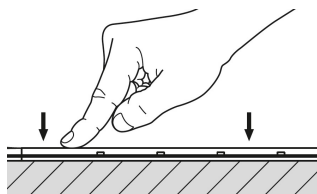

After assembly always check that the entire length of the tape has attached properly to the surface and that there is no air pockets underneath the PCB.

The thermal length expansion coefficient of the PCB is 17\*10<sup>-6</sup>cm/cm/K. When installing in environments with large variations in temperature (e.g. outdoor applications) and operating length of more than 2 m, the use of metallic mounting surfaces is necessary. Otherwise it is advisable to use an additional thicker adhesive tape to absorb the stress of any mismatch in expansion coefficients, e.g. 3M 9119-140 mic.

### Cutting

The LED-tape is separable at every 6 LEDs or multiple thereof with the full function of each LED segment. It is only allowed to cut the LED-tape at the indicated cutting line.

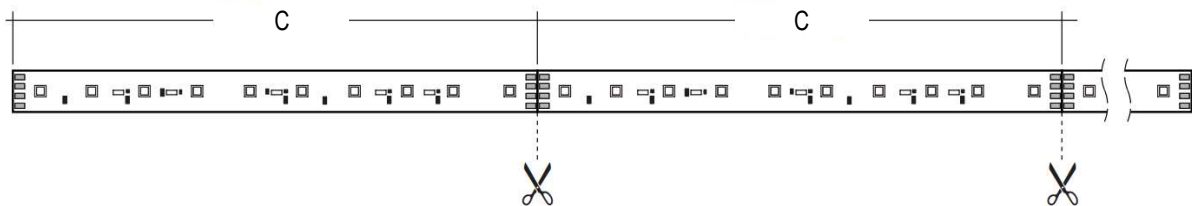

When cutting the IP65-version it is recommended to use the included silicon kit to re-seal the LED-tape according to the instructions on page 6.

### Soldering

#### Without heat sink:

- Pre-tin the cables only
- Soldering temperature max 300 °C during 4 seconds

#### With heat sink:

- Pre-tin solder pads and cables
- Soldering temperature max 350 °C during 3 seconds

## Wiring

Each reel of LED-tape is delivered with color coded connection cable L=350mm, 2x0,5 mm<sup>2</sup>. Do not connect more than 10 meters of the LED-tape in series. When connecting several sections in parallel please refer to the table *Driver & Control Systems* for the allowed total length connected to one controller/dimmer.

Color	Red	Black
Function	+	-

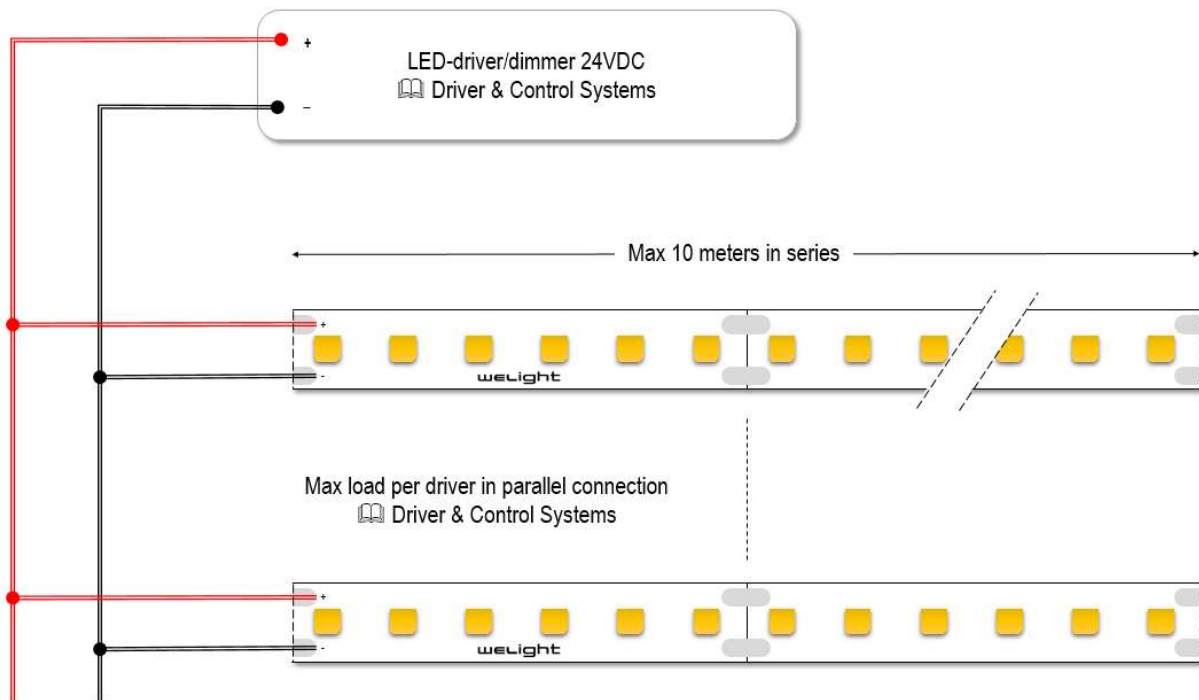

## LED Driver selection and connection

In order to drive weelight LED-tapes safely, it is absolutely necessary to operate them with an electronically stabilized power supply protecting against short circuits, overload and overheating. Always use our approved drivers and controls to power the LEDtape – refer to *Driver & Control Systems*. If the wrong type of driver is used the product warranty is void.

Electronic control gear for LED should carry the CE mark and ENEC certified. In Europe the declarations of conformity must include the following standards: CE: EC 61347-2-13, EN 55015, IEC 61547 and IEC 61000-3-2 - ENEC: 61347-2-13 and IEC/EN 62384. Also check for the mark of an independent authorized certification institute. Tridonic electronic control gear complies with all relevant standards and guarantees safe operation.

## How to cut and re-seal the IP-rated LEDTape

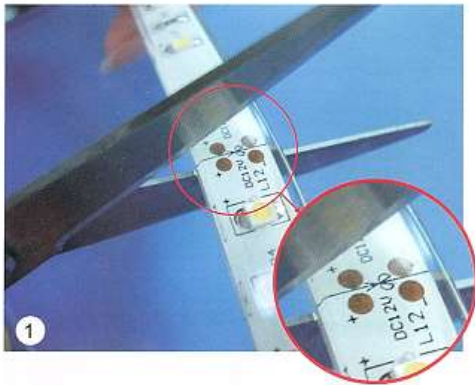

1. Please cut the LED strip at the cutting line.

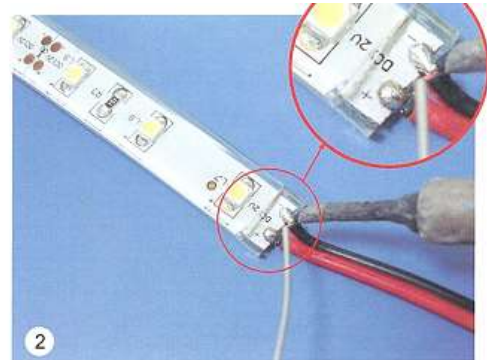

2. Rejoin the cables to the strip by soldering, please do not reverse the polarity.



3. Get the end-caps from the accessory bag, make a small hole on each end-cap.



4. Put the end-cap on the end of LED strip, get the wires through the small hole.



5. Twist off the cap of glue tube, make a hole on the tube with the awl of the cap or other sharp objects.



6-7. Put the needle on the top of glue tube, cut the top of the needle at an angle of 45~60 degrees.



8-9. Dispense the glue on the gap between the end-cap and LED strip, and the small hole on the end-cap. Please wait for 30 minutes till the glue gets solidified.



## Accessories

### Cable & Connection accessories

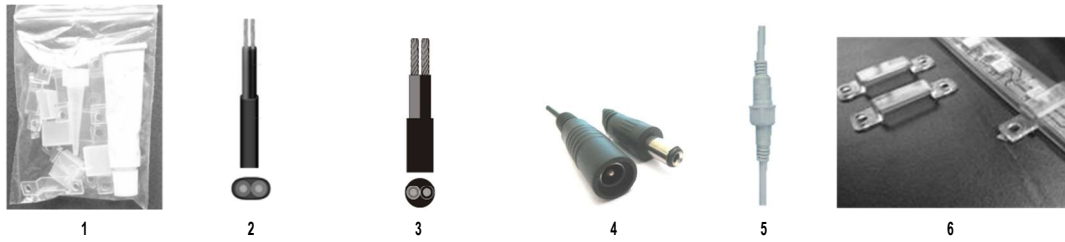

	Type	Art. Code	Description	LEDtape	
				IP20	IP65
1	LEDtape Accessory IP Assembly Kit 10	W8901	5 End Caps, 10 Mounting Brackets & Silicon (one kit is included on delivery)	○	●
2	LEDtape Accessory LED Cable 100m Indoor	W8407	H03VVH 2X0.75 Rd/Bl, White Insulation, 100 m	●	○
3	LEDtape Accessory LED Cable 100m Outdoor	RKKB2X1	RKKB 2X1 Rd/Bl Yd 5,8mm Black Insulation 100 m	○	●
4	LEDtape Accessory CON IP20 kit F+M	W8412-A1	Quick Connector kit with female and male plug including 30 cm cable, black	●	○
5	LEDtape Accessory CON IP68 kit F+M	W8411-A2	Quick Connector kit with female and male plug including 30 cm cable, white	○	●
6	LEDtape Accessory IP Clips 100-pack	W8902	Plastic mounting clips for all IP65-rated LEDtapes, 100 pcs per bag.	○	●

### Drivers & Dimmers

(a) Select the way you want to dim your system and (b) chose a driver that matches your LED-power.



(a)	Control Signal	Dimmer Type	Art. Code	Max length per dimmer	Multiple dimmers allowed
1	1-10V	fenofd analog 1-24e	00000066	16 meter	Yes
2	DALI	fenofd dali 1-24e	00004020	16 meter	Yes
3	DSI	fenofd dsi 1-24e	00004021	16 meter	Yes
4	switchDIM (phase impulse)	fenofd touch 1-24e	00004221	16 meter	Yes
5	DALI one4all integrated ① ②	Tridonic K210	8645937	2,9 meter	Yes
6	DMX	fenofd dmx 1-24e	00002100	16 meter	Yes
7	IP44 Dimmer Protection Kit	All of the above	24138842	-	-

① one4all supports switchDIM (dimming via phase impulse), DSI and DALI in the same dimmer.

② The dimmer has a 25W integrated LED-driver and cannot be used together with external LED-driver in table (b).

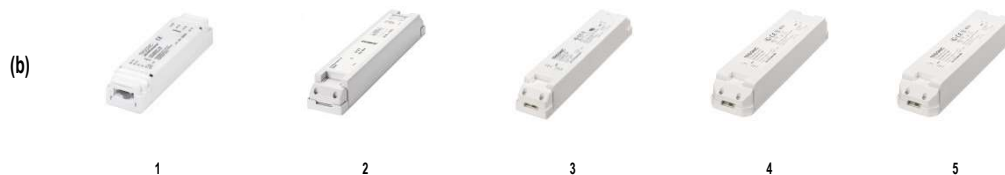

(b)	Power	Driver	IP20 Art. Code	IP67 Art. Code
1	25 W	Tridonic LCU 025/24	86453418	-
2	35 W	Tridonic LCU 035/24	24166320	-
3	60 W	Tridonic LCU 060/24	24166324	22185184
4	100 W	Tridonic LCU 100/24	24166328	22185185
5	150 W	Tridonic LCU 0150/24	24166333	22185186

LED-drivers <25 W available on request. Please contact us at [info@welight.se](mailto:info@welight.se) for information about suitable end-user control interfaces, e.g. touch panels, color mixing software, potentiometers, push-buttons, etc.

## Aluminum Profile Systems & Lenses

Start by selecting an aluminum profile (a) and a suitable lens cover (b) and then add optional accessories (c).

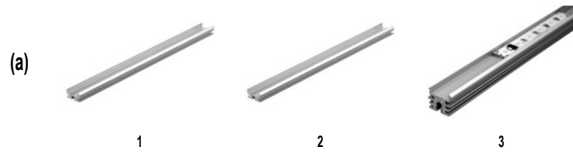

(a)	Type	Art. Code	L (mm)	W (mm)	H (mm)	W (mm) incl. lens cover	H (mm) incl. lens cover	Application	Optional accessories			
									Lens Cover	End Cap	Fixed Mount	Adjustable Mount
1	Z200-2	24166148	2000	18	9	21	16	Corner	●	○	○	○
2	Z201-2	24166149	2000	18	9	21	16	Linear Slim	●	●	●	○
3	Z22W-2	24166150	2000	18	16	21	24	Linear	●	●	●	●



(b)	Type	Art. Code	L (mm)	Typ. application	Profile		
					Z200-2	Z201-2	Z22W-2
1	15°	24166409	2000	Wall wash	●	●	●
2	30°	24166410	2000	Wall wash	●	●	●
3	60°	24166411	2000	Shelf	●	●	●
4	30° x 60°	24166412	2020	Asymmetric	●	●	●
5	Batwing	24166120	2000	Side-emitting	●	●	●
6	120°	24138737	2000	Accent	●	●	●
7	120° opal	24138736	2000	Lines	●	●	●

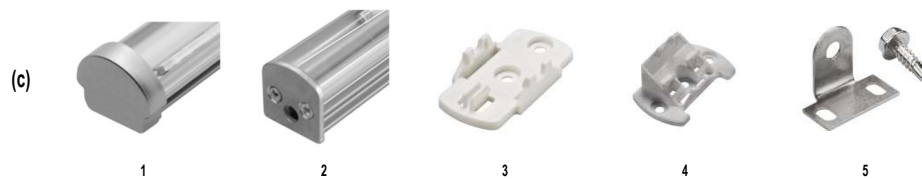

(c)	Type	Art. Code	Profile		
			Z200-2	Z201-2	Z22W-2
1	End cap Grey PMMA	24166334	○	●	○
2	End Cap Aluminum	24139174	○	○	●
2	End Cap Aluminum Cable Entry	24139173	○	○	●
3	Mounting Bracket 0°	88166859	○	●	●
4	Mounting Bracket 15°	88167372	○	●	●
4	Mounting Bracket 30°	88167373	○	●	●
4	Mounting Bracket 45°	88167374	○	●	●
4	Mounting Bracket 60°	88167375	○	●	●
5	Mounting Bracket Adjustable	24166024	○	○	●