

Highlights

- Ready-to-connect flexible LED-strip with extremely high light output and CRI – more than 2000 lumen per meter with CRI>90
- Industry leading efficiency – up to 100 lumen per watt
- Constant Current Driven IC for professional lighting applications
- Excellent white color consistency MacAdam SDCM ≤3
- Ultra-high color rendering index CRI>90
- Perfect for general lighting, e.g. slim linear profiles and luminaires
- Reflective white double-layered PCB for optimal system efficiency
- High quality adhesive 3M-tape on backside for easy mounting on clean surface or cooling profile
- Long lifetime: L70F10 = 50.000h ①

Applications

- General Lighting
- Office Lighting
- Indirect Lighting
- Area Lighting

Electrical Properties

- Supplied with constant voltage 24 VDC
- Stable photometrics in combination with wide input voltage range 24-26 V
- Connect up to 10 meters in series ⑥
- Optimized for high resolution dimming 0,1-100% using Tridonic and welight digital drivers controlled via switchDIM, DSI, DALI, 1-10V or DMX.

Standards

→ page 2

Drivers & Accessories

- Large selection of drivers and dimmers to fit every need and application
- Aluminum profiles for linear and corner applications
- Wide variety of lenses and covers 15°/30°/60°/120°/Asymmetric/Side-emitting
- Fixed or adjustable mounting brackets
- Solder-free connectors and bridges

→ page 4

Mounting Instructions

→ page 6

Type	Article Code	Supply Voltage (VDC) ③	Color (K)	Photometric Code ⑤	Typ. Data per meter ① ②				Pitch Distance (P)	Cutting Length (C)	LxWxH (mm)	Operating temp (°C) ④	EEL Energy Class
					Luminous flux (lm)	Current (mA)	Power (W)	LED quantity					
LEDtape 927 2000 PRO G3	W1006-927-G3	24	2700	927 / 349	1882	917	22	64	16 mm	110 mm	4950x10x2	-35 °C +50 °C	A+
LEDtape 930 2000 PRO G3	W1006-930-G3	24	3000	930 / 349	2088	917	22	64	16 mm	110 mm	4950x10x2	-35 °C +50 °C	A+
LEDtape 940 2000 PRO G3	W1006-940-G3	24	4000	940 / 349	2172	917	22	64	16 mm	110 mm	4950x10x2	-35 °C +50 °C	A+

① All values for ta = 25 °C / tc = 65 °C

② Tolerance range for electrical and optical data ±10%

③ Exceeding the maximum operating voltage leads to an overload on the tape. This may result in a significant reduction in lifetime or even destruction of the tape. Tolerance range for the supply voltage 24V: +/- 2V

④ External cooling is required

⑤ According to IEC 62717

⑥ When connecting 10 meter in series, the supply voltage must be between 24-26V at the beginning of the tape. Lower voltage can cause a significant reduction in light output at the end of length.

Standards

- IEC 62031
- IEC 62471
- IEC 62717
- IEC 6100-4-2
- IEC 62717

Thermal behavior

Storage Temperature	-30/+65 °C
Operating Temperature	-35/+50 °C
Tc max	75 °C

Relative luminous flux vs. ambient temperature

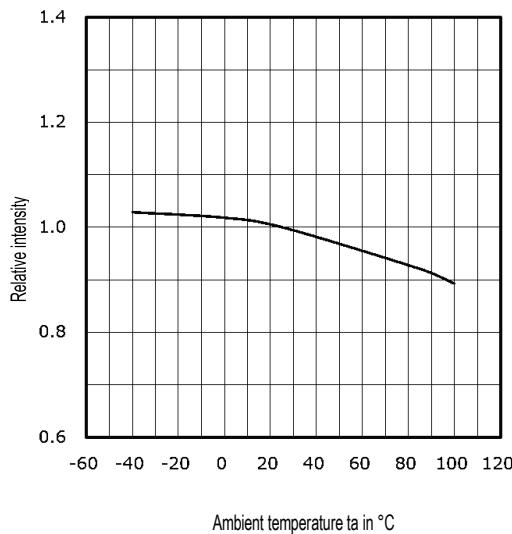

⚠ Thermal design and heat sink

The rated life of LED-products depends to a large extent on the temperature. Welight's excellent thermal design for the LEDTape products provides the lowest thermal resistance and therefore allowing new compact designs without sacrificing quality, safety and life time. However, if the permissible temperature limits are exceeded, the life of the LEDTape will be greatly reduced or the LEDTape may be destroyed.

It is necessary to mount the LEDTape onto a heat sink, e.g. an aluminum profile. The size of the heat sink is largely depending on the ambient temperature (t_a) of the application. The following tables should be seen as a guide to a recommended heat sink depending on different t_a :

LEDTape 2000 PRO (per meter)

Ambient Temperature (T_a)	Reference Temperature (T_c)	Cooling Area (cm^2)	Thermal Resistance R_{thS-A}	Recommended Aluminum profile
25 °C	65 °C	250	2,5 K/W	Z200-2 / Z201-2 / Z22W-2
30 °C	65 °C	300	2,1 K/W	Z200-2 / Z201-2 / Z22W-2
35 °C	65 °C	350	1,8 K/W	Z22W-2
45 °C	65 °C	450	1,7 K/W	Z22W-2

The temperature at tc reference point is crucial for the light output and life time of an LEDTape. For the welight LEDTape a tc temperature of 65 °C is recommended in order to achieve an optimum between heat sink requirements, light output and life time.

Life time, lumen maintenance and failure fraction

The light output of the LEDs on the tape decreases over the life-time, this is characterized with the L value. L70 means that the LEDTape will give 70 % of its initial luminous flux. This value is always related to the number of operation hours and therefore defines the lifetime of the LEDs.

The L value is a statistical value and the lumen maintenance may vary over the delivered LEDTapes. The B value defines the amount of LEDs which are below the specific L value, e.g. L70B10 means 10 % of the LEDs are below 70 % of the initial luminous flux, respectively 90 % will be above 70 % of the initial value.

In addition the percentage of failed LEDs (fatal failure) is characterized by the C value. The F value is the combination of the B and C value. That means for F degradation and complete failures are considered, e.g. L70F10 means 10 % of the LEDs on the tape may fail or be below 70 % of the initial luminous flux.

Type	Reference Temperature (T_c)	L90F10	L70F10
LEDTape 2000 PRO	65 °C	25 000 h	>50 000 h
	75 °C	12 000 h	32 000 h

⚠ The temperature on the surface of the LEDTape (t_c) may under no circumstances be higher than 65 °C if the expected lifetime of the LEDTape is to be met.

Compliance with the maximum permissible reference temperature at the tc point must be checked under operating conditions in a thermally stable state. The maximum value must be determined under worst-case conditions for the relevant application.

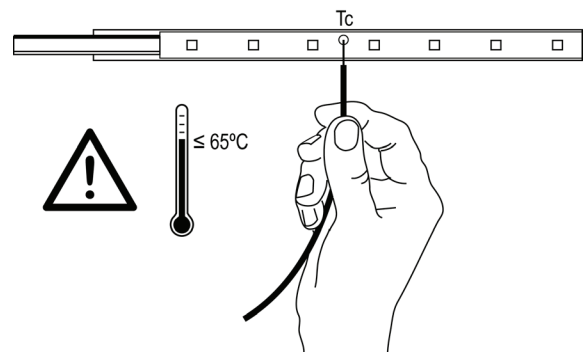

Light Distribution

Radiance Angle = 120°

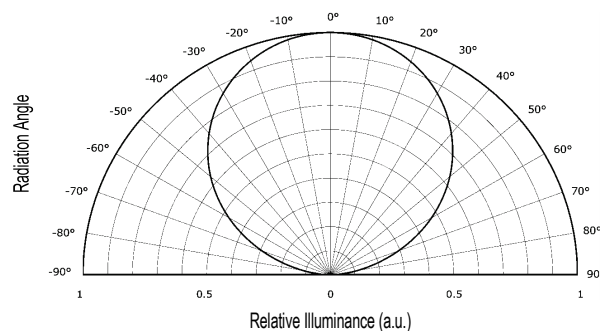

Photometric Code (according to EN 62717)

1 st digit		2nd + 3rd digit	4th digit	5th digit	6th digit	
Code	CRI				Code	Light Output
7	67 – 76	Color temperature in Kelvin x 100	Initial MacAdam ellipse SDCM	Maintained MacAdam ellipse SDCM after 25% of the lifetime (6000 h)	7	≥ 70 %
8	77 – 86				8	≥ 80 %
9	87 – ≥90				9	≥ 90 %

Chromaticity coordinates and tolerances (according to CIE 1931)

White Tone	CCT	Photometric Code
Incandescent	2700 K	927 / 349
Warm	3000 K	930 / 349
Neutral	4000 K	940 / 349

The specified color coordinates are measured by a current impulse with nominal values of module after a settling time of 100 msec. The ambient temperature of the measurement is $t_a = 25\text{ }^\circ\text{C}$. The measurement tolerance of the color coordinates are ± 0.01 .

2700 K	x0	y0
Centre	0,4578	0,4101

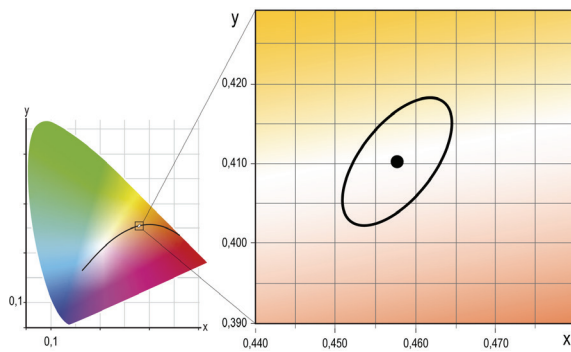

MacAdam ellipse: 3 SDCM

3000 K	x0	y0
Centre	0,4338	0,4030

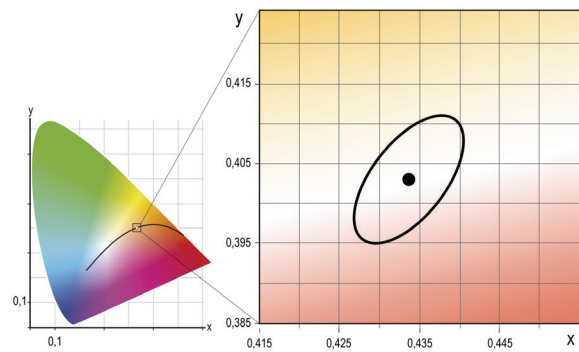

MacAdam ellipse: 3 SDCM

4000 K	x0	y0
Centre	0,3818	0,3797

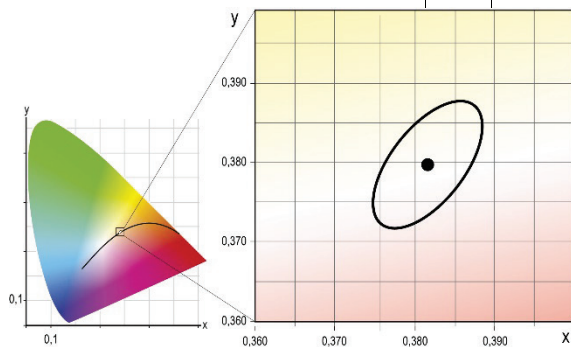

MacAdam ellipse: 3 SDCM

ACCESSORIES

Cable & Connection accessories

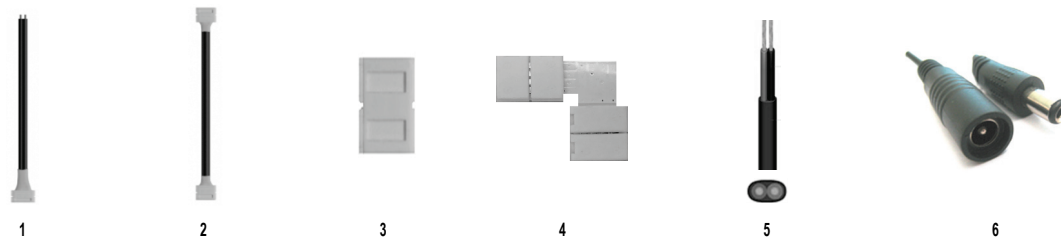

Type	Art. Code	Description
1 LEDtape Supply Cable 10/200	W8404	Supply cable with solder-free PCB-connection, L=200 mm
2 LEDtape Bridge Cable 10/200	W8405	Bridge two LEDtapes with solder-free PCB-connection, L=200 mm
3 LEDtape Bridge 10	W8406	Bridge two LEDtapes directly to each other with solder-free PCB-connection
4 LEDtape Corner Bridge 10	W8409	Bridge two LEDtapes 90 degrees directly to each other with solder-free PCB-connection
5 LEDaccessory LED Cable 100m Indoor	W8407	H03VVH 2X0.75 Rd/Bl, White Insulation, 100 m
6 LEDaccessory CON IP20 kit F+M	W8412-A1	Quick Connector kit with female and male plug including 30 cm cable, black

Drivers & Dimmers

(a) Select the way you want to dim your system and (b) chose a driver that matches your LED-power.



(a)	Control Signal	Dimmer Type	Art. Code	Max length per dimmer	Multiple dimmers allowed
1	switchDIM (phase impulse)	welight LEDcontrol 2x10A	W7003	2 x 10 meter	Yes (max 25)
1	DALI	welight LEDcontrol 2x10A	W7003	2 x 10 meter	Yes
2	one4all integrated ① ②	Tridonic LCA one4all PRE	28001253	4,5 meter	Yes
3	one4all integrated ① ②	Tridonic K210	28000858	1 meter	Yes
4	1-10V	feno fd analog 1-24e	00004023	6 meter	Yes
5	DMX	feno fd dmx 1-24e	00004022	6 meter	Yes
6	IP44 Dimmer Protection Kit	Type 3-5 above	24138842	-	-

① one4all supports ready2mains, corridorFUNCTION, switchDIM (dimming via phase impulse), DSI and DALI in the same dimmer.

② The dimmer has an integrated LED-driver and cannot be used together with external LED-driver in table (b).

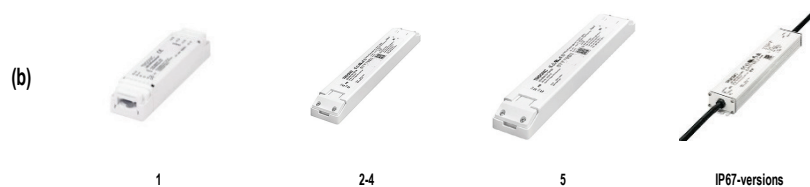

(b)	Power	Driver	IP20 Art. Code	IP67 Art. Code
1	25 W	Tridonic LCU 25W 24V	28000849	-
2	35 W	Tridonic LCU 35W 24V EXC	28000411	-
3	60 W	Tridonic LCU 60W 24V EXC	28000412	28000512
4	96 W	Tridonic LCU 96W 24V EXC	28000413	28000513
5	180 W	Tridonic LCU 180W 24V EXC	28000414	28000514

LED-drivers <25 W available on request. Please contact us at info@welight.se for information about suitable end-user control interfaces, e.g. touch panels, color mixing software, potentiometers, push-buttons, etc.

Aluminum Profile Systems & Lenses

Start by selecting an aluminum profile (a) and a suitable lens cover (b) and then add optional accessories (c).

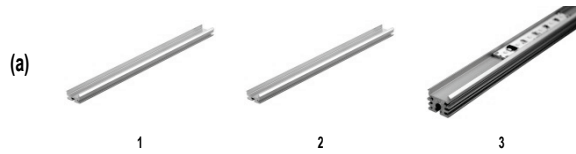

(a)	Type	Art. Code	L (mm)	W (mm)	H (mm)	W (mm) incl. lens cover	H (mm) incl. lens cover	Application	Optional accessories			
									Lens Cover	End Cap	Fixed Mount	Adjustable Mount
1	Z200-2	24166148	2000	18	9	21	16	Corner	●	○	○	○
2	Z201-2	24166149	2000	18	9	21	16	Linear Slim	●	●	●	○
3	Z22W-2	24166150	2000	18	16	21	24	Linear	●	●	●	●

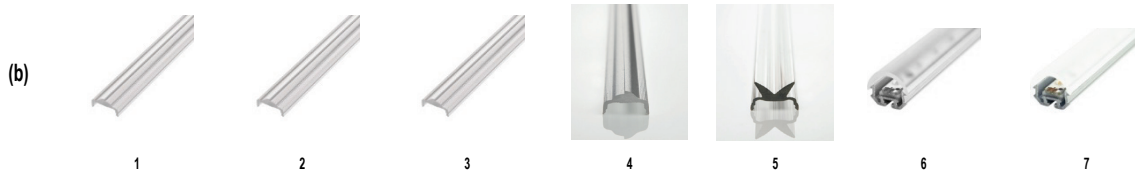

(b)	Type	Art. Code	L (mm)	Typ. application	Profile		
					Z200-2	Z201-2	Z22W-2
1	15°	24166409	2000	Wall wash	●	●	●
2	30°	24166410	2000	Wall wash	●	●	●
3	60°	24166411	2000	Shelf	●	●	●
4	30° x 60°	24166412	2020	Asymmetric	●	●	●
5	Batwing	24166120	2000	Side-emitting	●	●	●
6	120°	24138737	2000	Accent	●	●	●
7	120° opal	24138736	2000	Lines	●	●	●

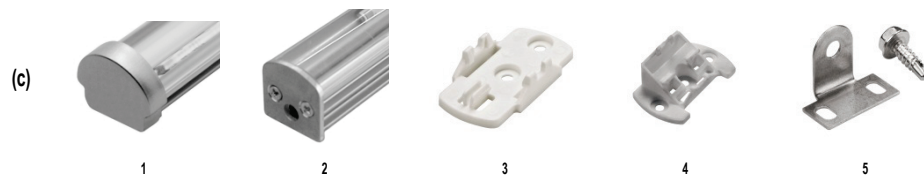

(c)	Type	Art. Code	Profile		
			Z200-2	Z201-2	Z22W-2
1	End cap Grey PMMA	24166334	○	●	○
2	End Cap Aluminum	24139174	○	○	●
2	End Cap Aluminum Cable Entry	24139173	○	○	●
3	Mounting Bracket 0°	88166859	○	●	●
4	Mounting Bracket 15°	88167372	○	●	●
4	Mounting Bracket 30°	88167373	○	●	●
4	Mounting Bracket 45°	88167374	○	●	●
4	Mounting Bracket 60°	88167375	○	●	●
5	Mounting Bracket Adjustable	24166024	○	○	●

 We also have complete profile systems for IP66 protection for demanding outdoor environments. Please contact us for further details.

LEDtape Indoor Series IP00

INSTRUKTIONER
INSTRUCTIONS
ANLEITUNG
ISTRUZIONI
INSTRUCCIONES

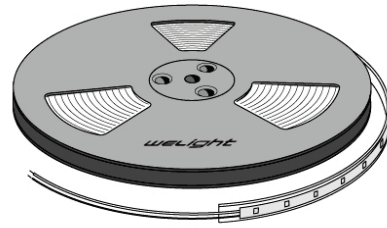

1.

Never bend the LEDtape at a radius smaller than 50 mm.

2.

Assembly must not damage or destroy conducting paths on the circuit board.

3.

The LED-tape is separable at every 4, 6 or 7 LEDs (depending on type) or multiple thereof with the full function of each LED segment. It is only allowed to cut the LED-tape at the indicated cutting line.

4.

Always cut the LEDtape in a straight line – 90 degrees in relation to the PCB edges. Failure to do so can result in damage of the internal conducting paths. It is recommended to use welight's official connection accessories to split, connect, bridge and re-seal the LED-tape.

5.

If you need to cut the LEDtape, re-join the supply cables to the strip by soldering. Please do not reverse polarity. Pre-tin the cables only. Soldering temperature max 300 °C during 4 seconds.

6.

The fixing/cooling surface must be properly cleaned to remove grease, dirt and silicon before application, e.g. using Isopropyl alcohol.

7.

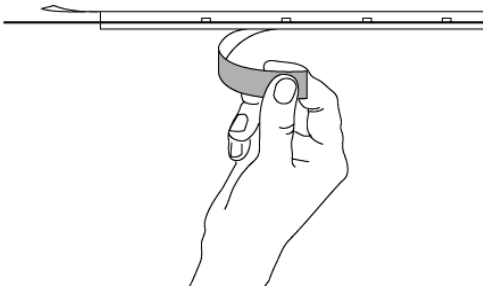

Remove the adhesive tape from the backside of the PCB and fix the LEDtape on the cleaned fixing/cooling surface.

8.

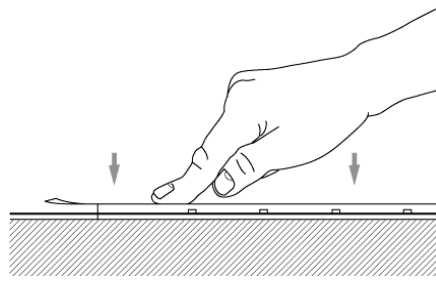

When fixing the LED-tape to a surface, apply an even but gentle pressure and try to avoid applying pressure directly on the LED itself (the maximum allowed pressure is 20 N/cm²).

After assembly always check that the entire length of the tape has attached properly to the surface and that there is no air pockets underneath the PCB.

9.

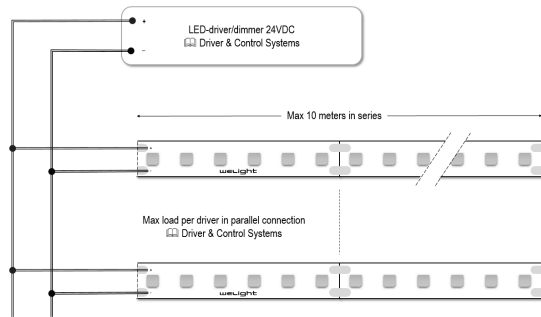

Each reel of LED-tape is delivered with colour coded connection cable L=350mm. Please take care about the polarity. Do not connect more than 10 meters of the LED-tape in series.

When connecting several sections in parallel please refer to the datasheet for the allowed total length connected to one controller/dimmer.

10.

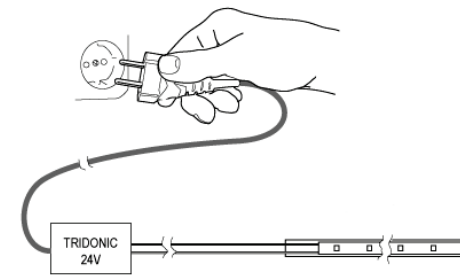

In order to drive welight LED-tapes safely, it is absolutely necessary to operate them with an electronically stabilized power supply protecting against short circuits, overload and overheating. Always use our approved drivers and controls to power the LEDtape – refer to Driver & Control Systems section in the datasheet.

If the wrong type of driver is used the product warranty is void.

11.

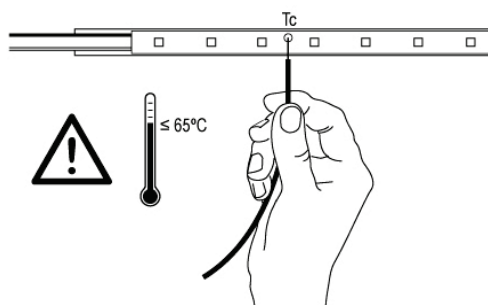

The temperature on the surface of the LEDtape (t_c) may under no circumstances be higher than 65 °C if the expected lifetime of the LEDtape is to be met.

Compliance with the maximum permissible reference temperature at the t_c point must be checked under operating conditions in a thermally stable state. The maximum value must be determined under worst-case conditions for the relevant application.

SAFETY INSTRUCTIONS

- EN** Read these instructions carefully before starting the installation and save for future reference. All connections to the device must be made by a qualified electrician or person with the necessary expertise in electrical installation in accordance with relevant rules and standards. Make sure that the mains voltage is disconnected before installation or maintenance.
- SE** Läs dessa instruktioner innan installationen påbörjas och lämna dem vidare till brukaren av anläggningen. All anslutning till enheten får endast utföras av behörig elektriker eller person med kännedom om elektrisk installation i enlighet med gällande regler och standard. Se till att spänningen är frånslagen före installation eller underhåll.
- FI** Lue nämä ohjeet ennen asentamista ja luovuta ohjeet valaisimen seuraavalle käyttäjälle. Kytkenät ohjaimen saa tehdä ainoastaan pätevä sähköasentaja tai sähköasennukset hallitseva henkilö voimassa olevien määräysten ja standardien mukaisesti. Varmista, että jännite on kytketty päältä ennen asennusta ja huoltoa.
- NO** Les disse instruksjonene før du starter installeringen, og gi den deretter videre til anleggets bruker. All tilkobling til enheten skal utføres av godkjent elektriker eller person med nødvendig kunnskap om elektrisk installasjon i henhold til gjeldende forskrifter og standard. Sørg for at strømmen er koblet fra før installering og ved vedlikehold.
- DK** Læs disse anvisninger før du starter installationen og aflever vejledningen til anlæggets bruger. Alle tilslutninger på enheden skal udføres af en autoriseret elinstallatør i overensstemmelse med gældende regler og standarder. Afbryd spænding før installation og vedligeholdelse.