



Driver LC 35W 250/300/350mA fixC Ip ADV

ADVANCED series

Product description

- Fixed output constant current built-in LED Driver
- Output current 250, 300 or 350 mA
- Max. output power 35 W
- Nominal life-time up to 50,000 h
- For class I luminaires
- Temperature protection as per EN 61347-2-13 C5e
- 5-year guarantee

Properties

- Low-profile metal casing with white cover
- Type of protection IP20

Functions

- Intelligent Temperature Guard (overtemperature protection)
- Short-circuit proof
- Overload protection
- Burst protection voltage 1 kV
- Surge protection voltage 1 kV (L to N)
- Surge protection voltage 2 kV (L/N to earth)



Standards, page 3



IP20      RoHS

Driver LC 35W 250/300/350mA fixC Ip ADV

ADVANCED series

Technical data

Rated supply voltage	220 – 240 V
AC voltage range	198 – 264 V
Typ. current (at 230 V, 50 Hz, full load)	0.19 A
Mains frequency	50 / 60 Hz
Overvoltage protection	300 V AC, 1 h
λ (at 230 V, 50 Hz, full load)	0.95
Leakage current (PE)	< 0.5 mA
THD (at 230 V, 50 Hz, full load)	< 20 %
Output current tolerance [®]	± 5 %
Typ. current ripple (at 230 V, 50 Hz, full load)	< 3 %
Max. output voltage	250 V
Time to light	< 0.5 s
Ambient temperature t_a	-20 ... +50 °C
Dimensions L x W x H	280 x 30 x 21 mm

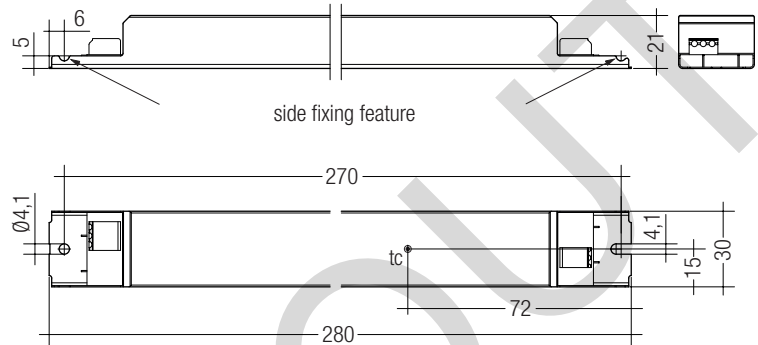

Ordering data

Type	Article number	Packaging carton	Packaging, low volume	Packaging, high volume	Weight per pc.
LC 35W 250mA fixC Ip ADV	87500453	50 pc(s).	900 pc(s).	2,700 pc(s).	0.183 kg
LC 35W 300mA fixC Ip ADV	87500454	50 pc(s).	900 pc(s).	2,700 pc(s).	0.183 kg
LC 35W 350mA fixC Ip ADV	87500455	50 pc(s).	900 pc(s).	2,700 pc(s).	0.183 kg

Specific technical data

Type	Output current [®]	Min. forward voltage	Max. forward voltage	Max. output power	Input power (at 230 V, 50 Hz, full load)	Input current (at 230 V, 50 Hz, full load)	Efficiency (at 230 V, 50 Hz, full load)	Max. peak output current	t_c point
LC 35W 250mA fixC Ip ADV	250 mA	47 V	140 V	35 W	39.5 W	190 mA	90 %	337.5 mA	70 °C
LC 35W 300mA fixC Ip ADV	300 mA	47 V	117 V	35 W	39.5 W	190 mA	89 %	405.0 mA	70 °C
LC 35W 350mA fixC Ip ADV	350 mA	45 V	100 V	35 W	39.5 W	190 mA	89 %	472.5 mA	70 °C

[®] Output current is mean value.

Standards

EN 55015
 EN 61000-3-2
 EN 61000-3-3
 EN 61347-2-13
 EN 62384
 EN 61547

Overload protection

LED Driver will switch off at overload operation. Mains reset is required to restart the LED Driver.

Overtemperature protection

The LED Driver will reduce output current at temporary thermal over-heating (exceeding max. tc point).

Short-circuit behaviour

LED Driver will switch off in case of short-circuit of LED output. Mains reset is required to restart the LED Driver.

No-load operation or load loss during operation

LED Driver will detect a load loss during operation. In this case and no-load operation the max. output voltage can apply at the LED output for max. 5 s before LED Driver shuts down. Mains reset is required to restart the LED Driver.

Humidity:

5 % up to max. 85%,
 not condensed
 (max. 56 days/year at 85%)

Storage temperature:

-40 °C up to max. +80 °C

The devices have to be within the specified temperature range (ta) before they can be operated.

Expected life-time

Type	ta	40 °C	50 °C	60 °C
LC 35W 250mA fixC Ip ADV	tc	60 °C	70 °C	x
	life-time	50,000 h	30,000 h	x
LC 35W 300mA fixC Ip ADV	tc	60 °C	70 °C	x
	life-time	50,000 h	30,000 h	x
LC 35W 350mA fixC Ip ADV	tc	60 °C	70 °C	x
	life-time	50,000 h	30,000 h	x

x = not permitted

The LED Drivers are designed for a life-time stated above under reference conditions and with a failure probability of less than 10 %.

Maximum loading of automatic circuit breakers

Automatic circuit breaker type	C10	C13	C16	C20	B10	B13	B16	B20	Inrush current	
Installation Ø	1,5 mm ²	1,5 mm ²	2,5 mm ²	2,5 mm ²	1,5 mm ²	1,5 mm ²	2,5 mm ²	2,5 mm ²	I_{max}	time
LC 35W 250mA fixC Ip ADV	24	42	46	54	12	21	23	27	23.3 A	168 µs
LC 35W 300mA fixC Ip ADV	24	42	46	54	12	21	23	27	23.3 A	168 µs
LC 35W 350mA fixC Ip ADV	24	42	46	54	12	21	23	27	23.3 A	168 µs

Harmonic distortion in the mains supply (at 230 V / 50 Hz and full load) in %

	THD	3.	5.	7.	9.	11.
LC 35W 250mA fixC Ip ADV	< 20	< 11	< 5	< 3	< 3	< 2
LC 35W 300mA fixC Ip ADV	< 20	< 11	< 5	< 3	< 3	< 2
LC 35W 350mA fixC Ip ADV	< 20	< 11	< 5	< 3	< 3	< 2

Installation instructions**Wiring type and cross section**

Solid wire with a cross section of 0.5 – 1.5 mm². Strip 8 – 9 mm of insulation from the cables to ensure perfect operation of terminals.

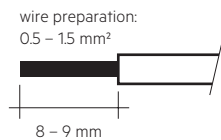
**Release of the wiring**

Loosen wire through twisting and pulling or using a Ø 1 mm release tool.

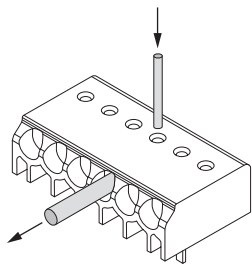
**Wiring guidelines**

- All connections must be kept as short as possible to ensure good EMI behaviour.
- Mains leads should be kept apart from LED Driver and other leads (ideally 5 – 10 cm distance)
- Max. length of output and I sel wires is 2 m.
- Secondary switching is not permitted.
- Incorrect wiring can damage LED modules.
- To avoid the damage of the Driver, the wiring must be protected against short circuits to earth (sharp edged metal parts, metal cable clips, louver, etc.).

Additional information

Additional technical information at www.tridonic.com → Technical Data

Guarantee conditions at www.tridonic.com → Services

Life-time declarations are informative and represent no warranty claim. No warranty if device was opened.

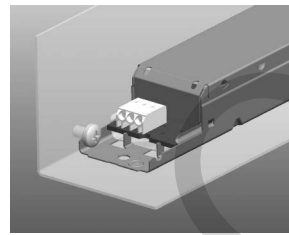
Side fixing feature

Screw M4, screw head diameter 8–10 mm

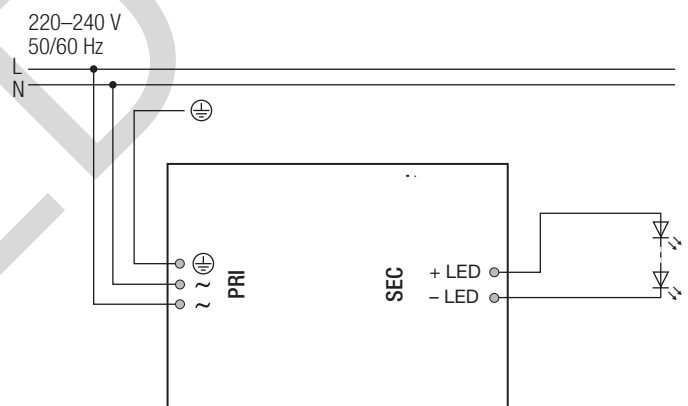
Circuit diagram**Isolation and electric strength testing of luminaires**

Electronic devices can be damaged by high voltage. This has to be considered during the routine testing of the luminaires in production.

According to IEC 60598-1 Annex Q (informative only!) or ENEC 303-Annex A, each luminaire should be submitted to an isolation test with 500 V_{DC} for 1 second. This test voltage should be connected between the interconnected phase and neutral terminals and the earth terminal. The isolation resistance must be at least 2 MΩ.

As an alternative, IEC 60598-1 Annex Q describes a test of the electrical strength with 1500 V_{AC} (or 1.414 x 1500 V_{DC}). To avoid damage to the electronic devices this test must not be conducted.

Diagrams LC 35W 250mA fixC Ip ADV

Efficiency vs load

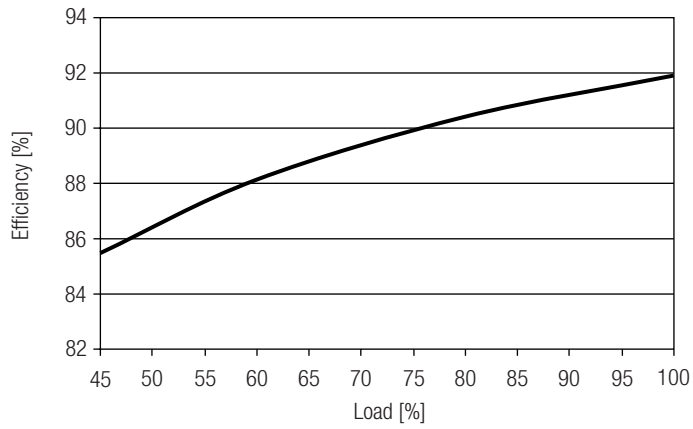

Power factor vs load

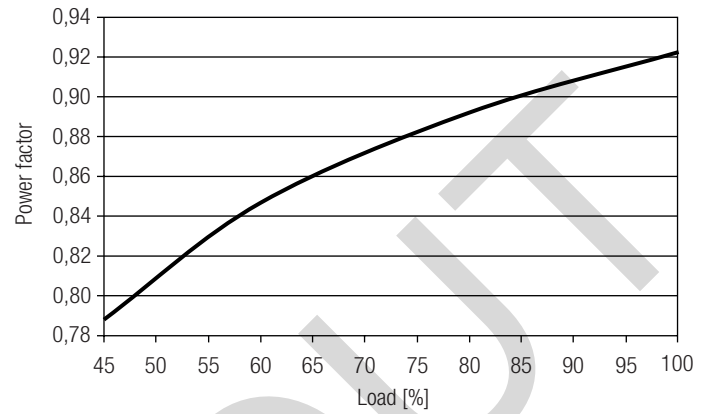

Input power vs load

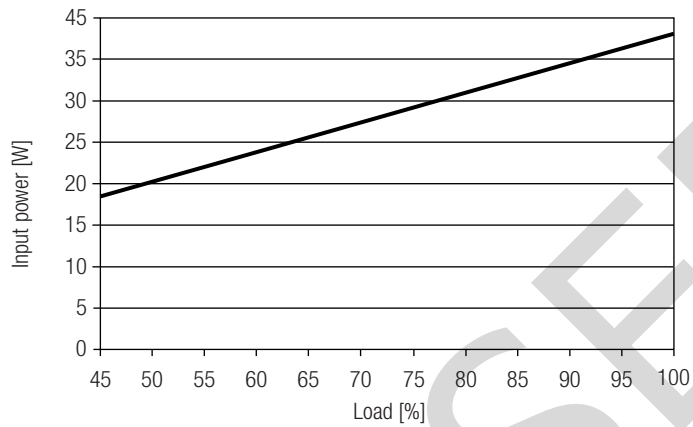

Input current vs load

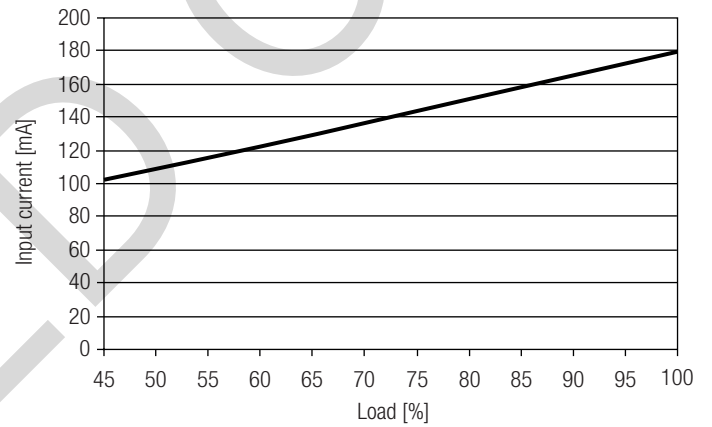

THD vs load

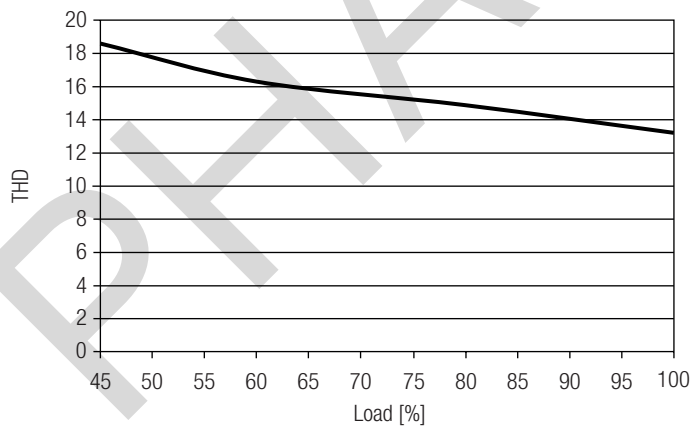

Diagrams LC 35W 300mA fixC Ip ADV

Efficiency vs load

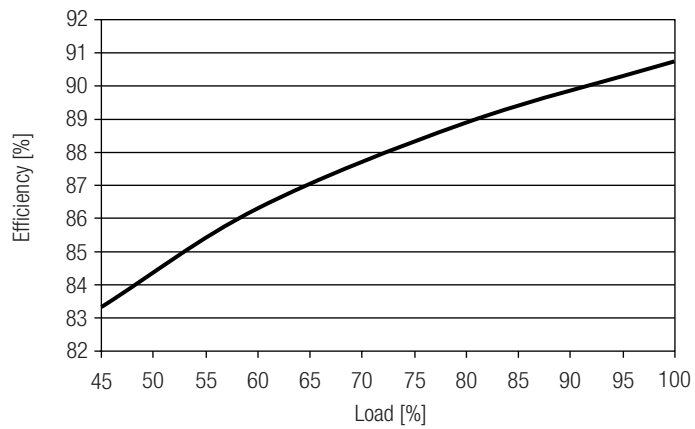

Power factor vs load

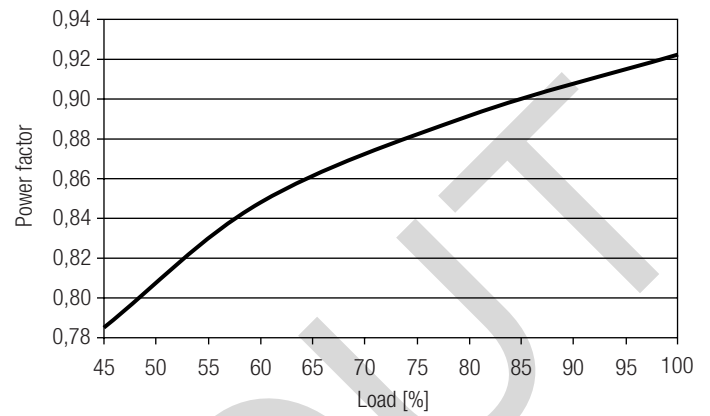

Input power vs load

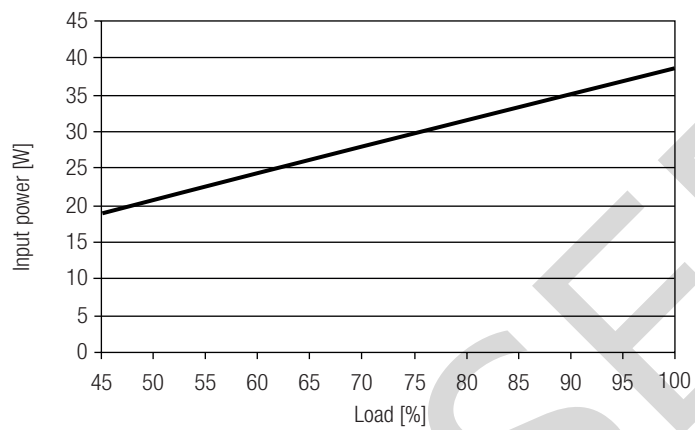

Input current vs load

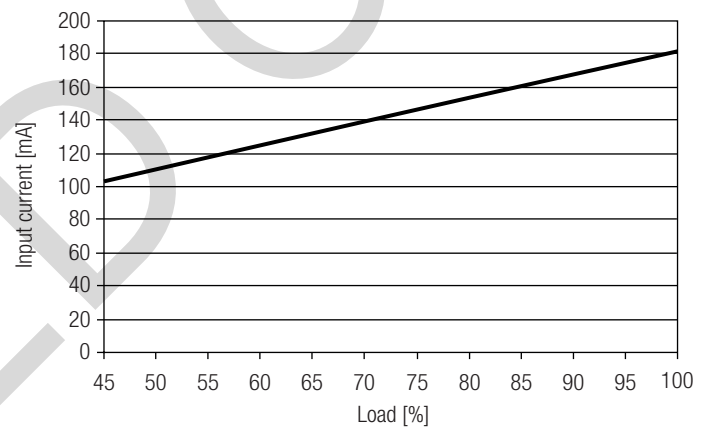

THD vs load

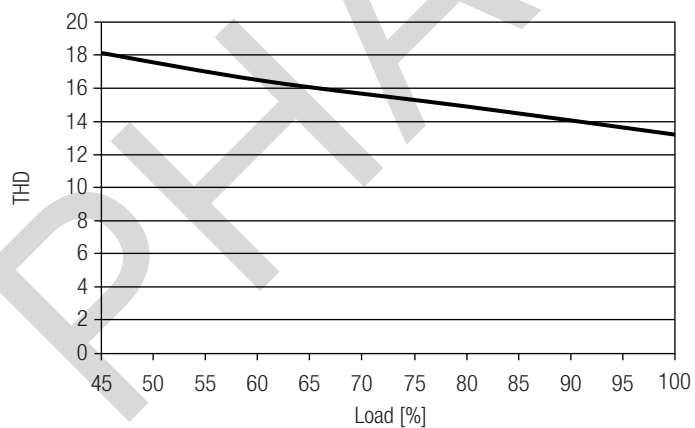

Diagrams LC 35W 350mA fixC Ip ADV

Efficiency vs load

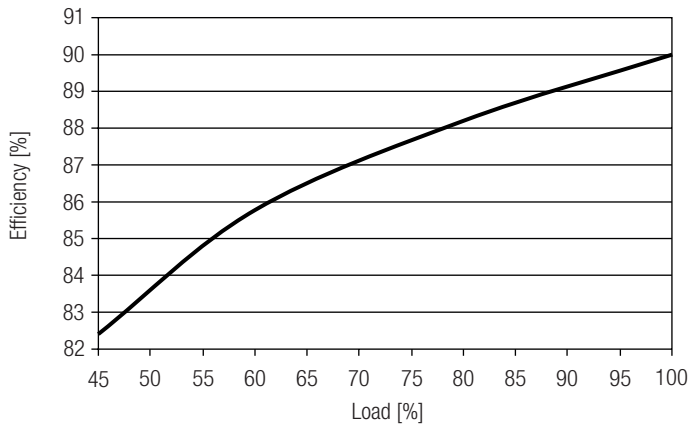

Power factor vs load

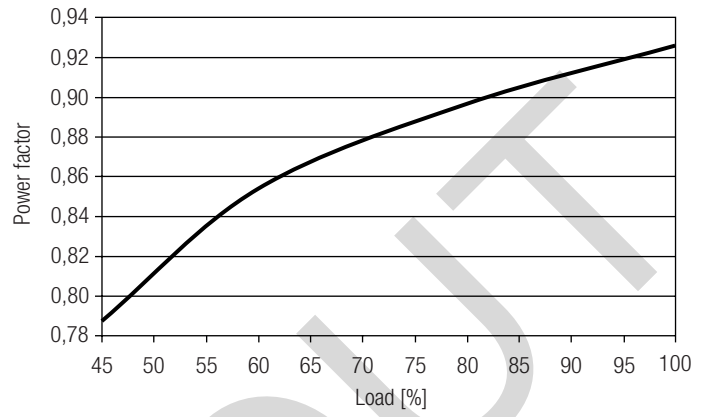

Input power vs load

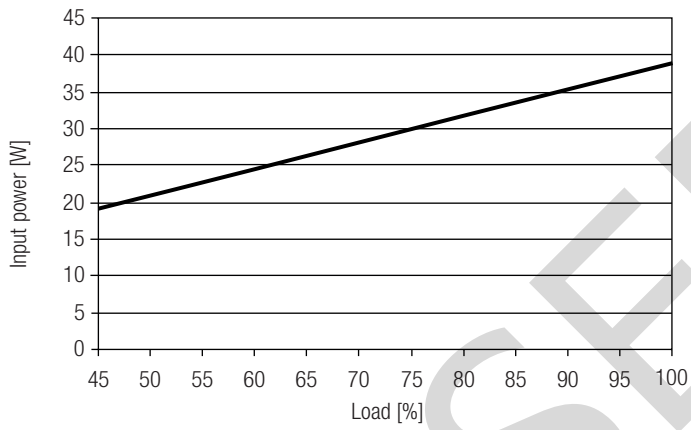

Input current vs load

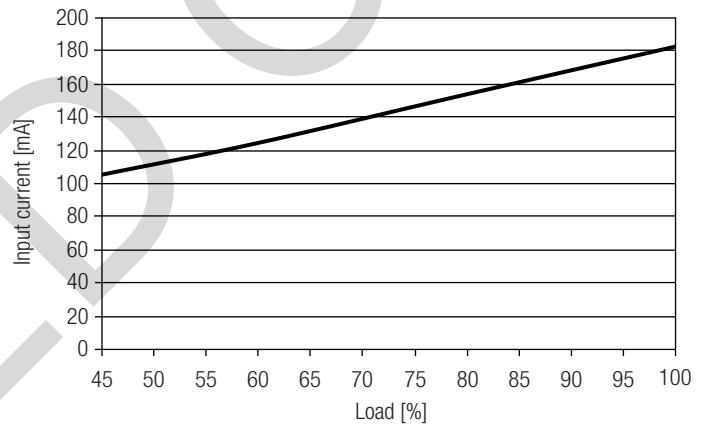

THD vs load

