

TALEXchain P561 G1 EXCITE  
TALEXchain**Product description**

- LED chain for highlighting lines and edges and for backlighting complex contours, letters, symbols and light boxes in signage applications
- Optimised for use in light boxes and sail installation backlighting
- High colour consistency (MacAdam 5)
- Standard beam characteristic: 155°
- High luminous efficacy
- LED module with plastic casing and strain relief with IP68 protection
- Integrated current source to stabilise luminous flux
- Flexible chain, can be split between any module
- Attached with M3 screw or premounted double-sided adhesive tape
- Nominal life-time up to 50,000 h (at  $t_a$  60 °C with a failure rate max. 0.2 % per 1,000 h)

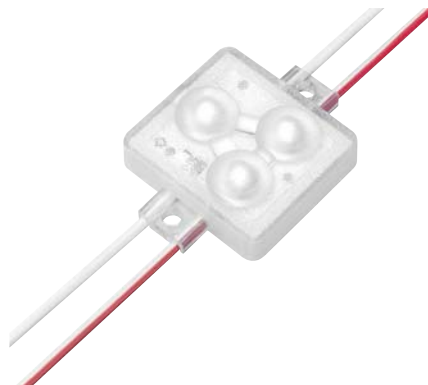

**Standards**, page 4

**Colour temperatures and tolerances**, page 6

IP68  

TALEXchain P561 G1 EXCITE  
TALEXchain

Technical data

Ambient temperature $t_a$	-40 ... +60 °C
Max. surface temperature on module $t_c$ <sup>①</sup>	65 °C
Storage temperature $t_s$	-40 ... +85 °C
Type of protection <sup>②</sup>	IP68
Risk group (EN 62471:2008)	0

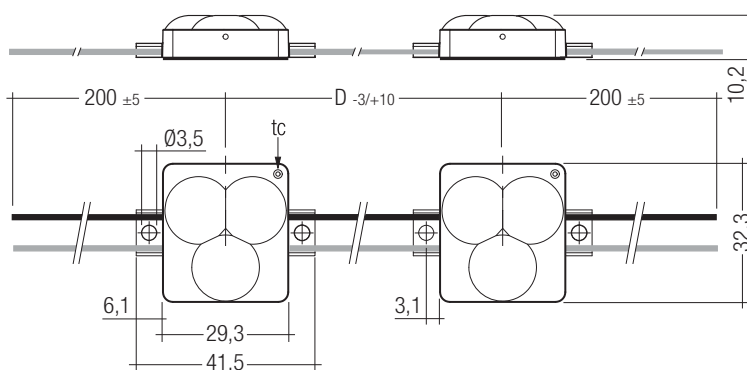

Ordering data

Colour	Colour temperature	Type	Article number	Packaging, roll	Packaging, carton	Packaging, pallet
<b>3 light points per module</b>						
Daylight white	6,500 K	P561 G1 DL 154lm 250mm 50 68 EXC	28000958	1 pc(s).	30 pc(s).	180 pc(s).
Daylight white	6,500 K	P561 G1 DL 154lm 300mm 50 68 EXC	28000959	1 pc(s).	30 pc(s).	180 pc(s).
Neutral white	4,000 K	P561 G1 NW 142lm 300mm 50 68 EXC	28000960	1 pc(s).	30 pc(s).	180 pc(s).
Warm white	3,000 K	P561 G1 WW 130lm 300mm 50 68 EXC	28000957	1 pc(s).	30 pc(s).	180 pc(s).

Specific technical data

Type	Photometric code <sup>②</sup>	Wavelength range	Colour temperature <sup>③</sup>	Typ. luminous flux per module <sup>②</sup>	Colour rendering index CRI <sup>②</sup>	Supply voltage DC <sup>④</sup>	Typ. current per module <sup>②</sup>	Typ. power per module	Luminous efficacy
<b>3 light points per module</b>									
P561 G1 DL	765/5xx	–	6,500 K	154 lm	>70	12 V	123 mA	1.48 W	104 lm/W
P561 G1 NW	840/5xx	–	4,000 K	142 lm	>80	12 V	123 mA	1.48 W	96 lm/W
P561 G1 WW	830/5xx	–	3,000 K	130 lm	>80	12 V	123 mA	1.48 W	88 lm/W

<sup>①</sup> If the max. temperature limits are exceeded, the life of the module will be greatly reduced or the module may be damaged.  
For the precise position of the  $t_c$  point see the above diagram.

<sup>②</sup> Tolerance range for optical and electrical data: ±15 %.

<sup>③</sup> Exceeding the max. operating voltage leads to an overload on the TALEXchain.  
This may in turn result in a reduction in life-time or even in destruction.  
Tolerance range for the supply voltage: 12 V: +2 V / -0 V.

<sup>④</sup> Maximum submerge depth 1 m / 60 min.

<sup>⑤</sup> Colour temperature for information only. Valid colour see „Coordinates and tolerances according to CIE 1931“.

<sup>⑥</sup> Photometric code in evaluation.

All values at  $t_a = 25$  °C.

### Type code

Example: P561 G1 DL 154lm 250mm 50 68 EXC

P561	TALEXchain type
G1	Generation = 1
DL	Colour = Daylight white
154lm	Typ. luminous flux
250mm	Module distance D = 250 mm
50	Number of modules = 50
68	Type of protection = IP68
EXC	EXC = product layer

For more information please call or email your Tridonic contact.

### Photometric code

Key for photometric code, e. g. 861/449

1 <sup>st</sup> digit	2 <sup>nd</sup> + 3 <sup>rd</sup> digit	4 <sup>th</sup> digit	5 <sup>th</sup> digit	6 <sup>th</sup> digit	
Code	CRI	Colour temperature in Kelvin x 100	McAdams after 25% of the life-time (max.6000h)	Lumen maintenance after 25% of the life-time (max.6000h)	
				Code	Remaining lumen
7	67 – 76			7	≥ 70 %
8	77 – 86			8	≥ 80 %
9	87 – ≥90			9	≥ 90 %

### LED control gear matrix – TALEXchain CRYSTAL SELECT

Type	IN-BUILT LCU <sup>®</sup>					REMOTE LCU <sup>®</sup>			
	LCU 015/12 D010	LCU 035/12 D010	LCU 060/12 D010	LCU 100/12 D010	LCU 150/12 D010	LCU 035/12 E020	LCU 060/12 E020	LCU 100/12 E020	LCU 150/12 E020
Article number	24166316	24166318	24166322	24166326	24166331	24166319	24166323	24166327	24166332

Assignable LED control gear

Assignable LED control gear

Type	Number of modules										Max. chaining
	Min.	Max.	Min.	Max.	Min.	Max.	Min.	Max.	Min.	Max.	
P561 G1 DL	1	8	4	20	5	35	9	58	18	88	100
P561 G1 NW	1	8	4	20	5	35	9	58	18	88	100
P561 G1 WW	1	8	4	20	5	35	9	58	18	88	100

<sup>®</sup> Type of protection IP67.

<sup>®</sup> Type of protection IP20.

**Standards**

- EN 62031
- EN 62471

The product meets the “inbuilt LED module” classification according to EN 62031.  
The product passed the glow-wire test with 850 °C according to EN 62031.

**Certificates**

**Thermal behaviour**

operation temperature (operation, no defects)	ta	- 40 → + 60 °C
storage temperature	ts	- 40 → + 85 °C
max. temperature tc point	tc	65 °C

The values apply to operation at 100 % output, natural convection.  
If the maximum temperature limits are exceeded, the life of the module will be greatly reduced. The module can fail within a short time. The tc point temperature of the module has to be measured in the thermally stable state and under operating conditions. Measurement setup e.g. according to IEC/EN 60598-1.

**Maintenance note**

The product is maintenance free. If cleaning during application only clear water without the addition of cleaning agents should be used.

**Label product (sample)**

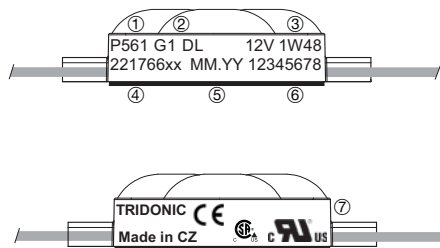

- ① Type
- ② Generation
- ③ Electr. specification
- ④ Article code
- ⑤ Production date
- ⑥ Production batch
- ⑦ Normative symbols

**Label product packaging (sample)**



- ① Type
- ② Packaging quantity
- ③ Article code
- ④ Production date
- ⑤ Barcode EAN13 for packaging unit
- ⑥ Barcode EAN128 (includes EAN13 and batch number)

**Label carton (sample)**



- ① Type
- ② Packaging quantity
- ③ Article code
- ④ Production date
- ⑤ Barcode EAN13 for packaging unit
- ⑥ Barcode EAN128 (includes EAN13 and batch number)

### Wiring

Cable: AWG 18

Colour	red-white	white
Function	+	-

### Wiring example

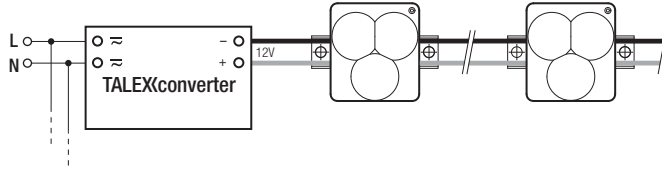

### Empirical values for decrease of luminous flux over the chain

Colour	Module distance	Module distance	Number of modules
	250 mm	300 mm	
Crystal white	21 %	34 %	50
Daylight white	21 %	34 %	50
Neutral white	21 %	34 %	50

Beam characteristics 155°

Light distribution  $I_v/I_{vmax}$ .

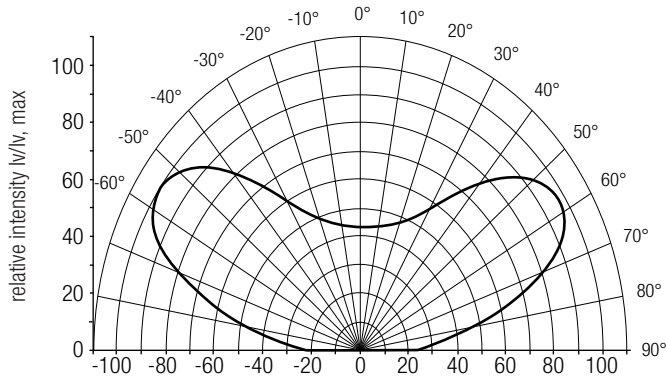

Coordinates and tolerances according to CIE 1931

Warm white (WW)

	x0	y0
Centre	0.4345	0.4033

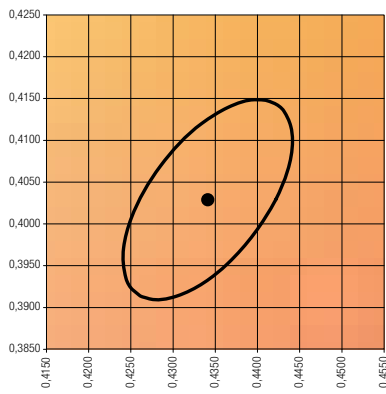

MacAdam ellipse: 5SDCM

Neutral white (NW)

	x0	y0
Centre	0.3825	0.3796

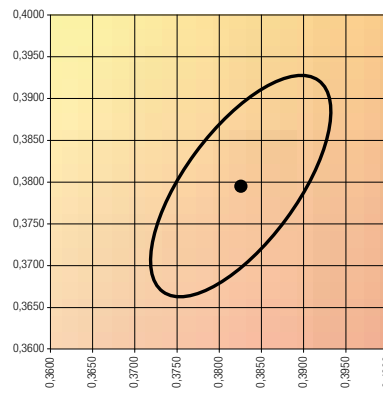

MacAdam ellipse: 5SDCM

Daylight white (DL)

	x0	y0
Centre	0.3154	0.3305

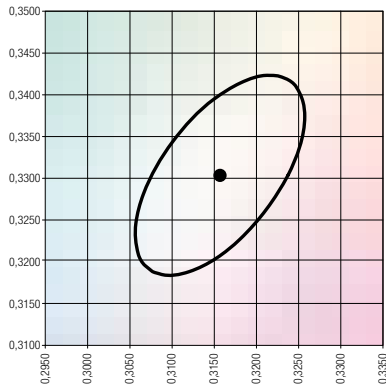

MacAdam ellipse: 5SDCM

