

**Module LLE 24mm 1250lm High Output HV ADV1**

Modules LLE advanced



LLE 24x280mm 1250lm HO HV ADV1



LLE 24x560mm 2400lm HO HV ADV1



For articles manufactured at Tridonic SRB d.o.o.

**Product description**

- \_ Precise light control and homogeneous appearance through specially designed single light point lens (ACL LENS 43x280 mm 30° / 60° / 90° / ASY / DASYS)
- \_ Operating mode up to 700 mA
- \_ Ideal for linear and panel lights
- \_ 2 terminals for serial wiring
- \_ Perfectly uniform light, even if several LED modules are used together in a line
- \_ Push terminals for quick and simple wiring of LED module to LED module
- \_ HE ... High Efficiency, NM ... Nominal Mode, HO ... High Output
- \_ Long lifetime up to 72,000 hours
- \_ 5 years guarantee (conditions at <https://www.tridonic.com/manufacturer-guarantee-conditions>)

**Optical properties**

- \_ Colour temperatures 3,000, 4,000 and 5,000 K
- \_ Useful luminous flux 2,570 lm at Irated and tp = 25 °C
- \_ Efficacy of the LED module 196 lm/W at Irated and tp = 25 °C
- \_ High colour rendering index CRI > 80
- \_ High colour consistency (MacAdam 3) ①
- \_ Small luminous flux tolerances

**Mechanical properties**

- \_ Module dimension 24 x 280 mm and 24 x 560 mm (ZHAGA compliant)
- \_ Simple installation via clips or screws

**System solution**

- \_ Combine Tridonic's LED modules and dimmable drivers to achieve an outstanding system efficacy (configuration possible via <https://setbuilder.tridonic.com/>)
- \_ Ideal combination of optimally matched module and lens components (ACL LENS 43x280 mm 30° / 60° / 90° / ASY / DASYS)

① Integral measurement over the complete module.

**Website**

<http://www.tridonic.com/28003528>

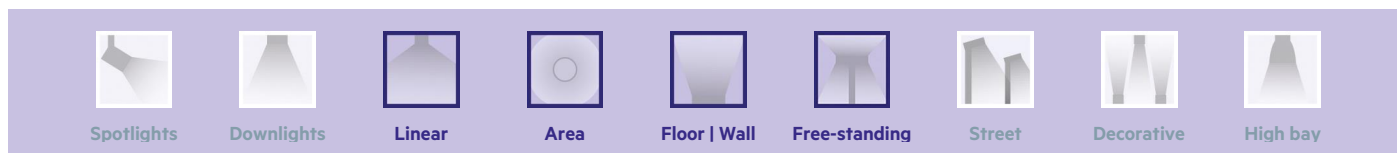
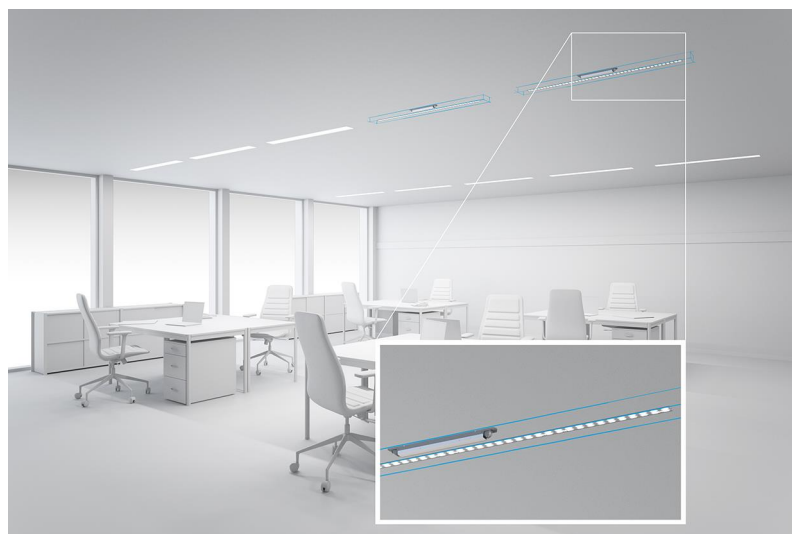

**Module LLE 24mm 1250lm High Output HV ADV1**

Modules LLE advanced

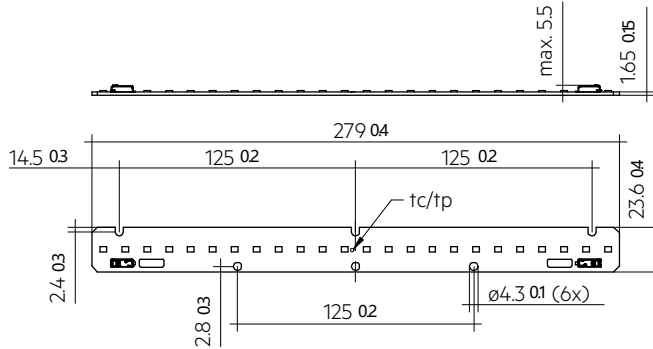

LLE 24x280mm 1250lm HO HV ADV1

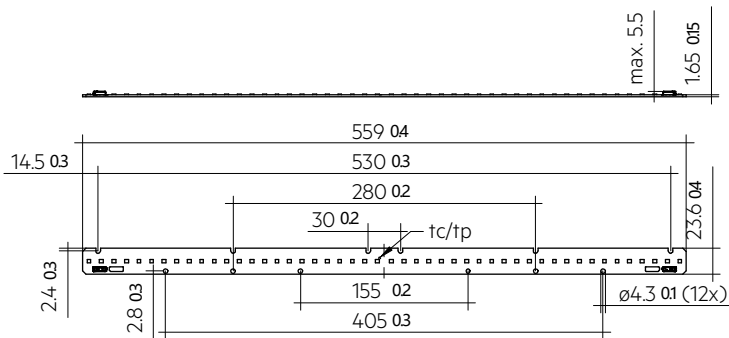

LLE 24x560mm 2400lm HO HV ADV1

**Ordering data**

Type	Article number	Colour temperature	Packaging, carton	Weight per pc.
LLE 24x280mm 1250lm 830 HO HV ADV1	28003528	3,000 K	108 pc(s).	0.021 kg
LLE 24x280mm 1250lm 840 HO HV ADV1	28003529	4,000 K	108 pc(s).	0.021 kg
LLE 24x280mm 1250lm 850 HO HV ADV1	28003734	5,000 K	108 pc(s).	0.021 kg
LLE 24x560mm 2400lm 830 HO HV ADV1	28003530	3,000 K	108 pc(s).	0.041 kg
LLE 24x560mm 2400lm 840 HO HV ADV1	28003531	4,000 K	108 pc(s).	0.041 kg
LLE 24x560mm 2400lm 850 HO HV ADV1	28003739	5,000 K	108 pc(s).	0.041 kg

**Technical data**

Beam characteristic	120°
Ambient temperature ta	-40 ... +65 °C
tp rated	50 °C
tc	85 °C
Irated	300 mA
I <sub>max</sub>	750 mA
Max. permissible LF current ripple	825 mA
Max. permissible peak current	1,050 mA / max. 10 µs
Max. working voltage for insulation <sup>®</sup>	440 V
Insulation test voltage	1.88 kV
CTI of the printed circuit board	≥ 600
ESD classification	Severity level 1
Risk group (IEC 62471) at ≤ 225 mA	RG0
Risk group (IEC 62471) at I <sub>max</sub>	RG1
Classification acc. to IEC 62031	Built-in
Type of protection	IPO0
Lumen maintenance L70B50	72,000 h
Guarantee (conditions at www.tridonic.com)	5 Year(s)

**Approval marks****Standards**

IEC 62031, IEC 62471, IEC 61000-4-2, IEC 62778, IEC 61547

**Specific technical data**

Type	Article number	Photometric code	Useful luminous flux at tp = 25 °C <sup>③</sup>	Expected luminous flux at tp rated <sup>④</sup>	Typ. forward current	Min. forward voltage at tp rated	Max. forward voltage at tp = 25 °C	Power consumption P <sub>on</sub> at tp = 25 °C <sup>⑤</sup>	Efficacy of the module at tp = 25 °C	Expected efficacy of the module at tp rated	Colour rendering index CRI
<b>Operating mode HE at 200 mA</b>											
LLE 24x280mm 1250lm 830 HO HV ADV1	28003528	830/359	-	760 lm	200 mA	19.5 V	23.1 V	-	-	176 lm/W	> >80
LLE 24x280mm 1250lm 840 HO HV ADV1	28003529	840/359	-	840 lm	200 mA	19.5 V	23.1 V	-	-	196 lm/W	> >80
LLE 24x280mm 1250lm 850 HO HV ADV1	28003734	850/359	-	821 lm	200 mA	19.5 V	23.1 V	-	-	191 lm/W	> >80
LLE 24x560mm 2400lm 830 HO HV ADV1	28003530	830/359	-	1,520 lm	200 mA	39.0 V	46.2 V	-	-	177 lm/W	> >80
LLE 24x560mm 2400lm 840 HO HV ADV1	28003531	840/359	-	1,654 lm	200 mA	39.0 V	46.2 V	-	-	194 lm/W	> >80
LLE 24x560mm 2400lm 850 HO HV ADV1	28003739	850/359	-	1,646 lm	200 mA	39.0 V	46.2 V	-	-	192 lm/W	> >80
<b>Operating mode NM at 300 mA</b>											
LLE 24x280mm 1250lm 830 HO HV ADV1	28003528	830/359	1,170 lm	1,130 lm	300 mA	19.9 V	23.6 V	6.64 W	176 lm/W	170 lm/W	> >80
LLE 24x280mm 1250lm 840 HO HV ADV1	28003529	840/359	1,300 lm	1,250 lm	300 mA	19.9 V	23.6 V	6.64 W	196 lm/W	190 lm/W	> >80
LLE 24x280mm 1250lm 850 HO HV ADV1	28003734	850/359	1,276 lm	1,227 lm	300 mA	19.9 V	23.6 V	6.64 W	192 lm/W	186 lm/W	> >80
LLE 24x560mm 2400lm 830 HO HV ADV1	28003530	830/359	2,350 lm	2,250 lm	300 mA	39.9 V	47.1 V	13.28 W	177 lm/W	171 lm/W	> >80
LLE 24x560mm 2400lm 840 HO HV ADV1	28003531	840/359	2,570 lm	2,462 lm	300 mA	39.9 V	47.1 V	13.28 W	194 lm/W	188 lm/W	> >80
LLE 24x560mm 2400lm 850 HO HV ADV1	28003739	850/359	2,549 lm	2,450 lm	300 mA	39.9 V	47.1 V	13.28 W	192 lm/W	186 lm/W	> >80
<b>Operating mode HO at 500 mA</b>											
LLE 24x280mm 1250lm 830 HO HV ADV1	28003528	830/359	-	1,850 lm	500 mA	20.8 V	24.5 V	-	-	162 lm/W	> >80
LLE 24x280mm 1250lm 840 HO HV ADV1	28003529	840/359	-	2,060 lm	500 mA	20.8 V	24.5 V	-	-	181 lm/W	> >80
LLE 24x280mm 1250lm 850 HO HV ADV1	28003734	850/359	-	2,008 lm	500 mA	20.8 V	24.5 V	-	-	176 lm/W	> >80
LLE 24x560mm 2400lm 830 HO HV ADV1	28003530	830/359	-	3,710 lm	500 mA	41.6 V	48.9 V	-	-	163 lm/W	> >80
LLE 24x560mm 2400lm 840 HO HV ADV1	28003531	840/359	-	4,057 lm	500 mA	41.6 V	48.9 V	-	-	179 lm/W	> >80
LLE 24x560mm 2400lm 850 HO HV ADV1	28003739	850/359	-	4,027 lm	500 mA	41.6 V	48.9 V	-	-	176 lm/W	> >80
<b>Operating mode HO at 700 mA</b>											
LLE 24x280mm 1250lm 830 HO HV ADV1	28003528	830/359	-	2,560 lm	700 mA	21.6 V	25.3 V	-	-	154 lm/W	> >80
LLE 24x280mm 1250lm 840 HO HV ADV1	28003529	840/359	-	2,850 lm	700 mA	21.6 V	25.3 V	-	-	172 lm/W	> >80
LLE 24x280mm 1250lm 850 HO HV ADV1	28003734	850/359	-	2,780 lm	700 mA	21.6 V	25.3 V	-	-	168 lm/W	> >80
LLE 24x560mm 2400lm 830 HO HV ADV1	28003530	830/359	-	5,130 lm	700 mA	43.2 V	50.5 V	-	-	155 lm/W	> >80
LLE 24x560mm 2400lm 840 HO HV ADV1	28003531	840/359	-	5,603 lm	700 mA	43.2 V	50.5 V	-	-	170 lm/W	> >80
LLE 24x560mm 2400lm 850 HO HV ADV1	28003739	850/359	-	5,574 lm	700 mA	43.2 V	50.5 V	-	-	168 lm/W	> >80

② If mounted with M4 screws and plastic washers.

③ Tolerance of useful light flux - 0 % / + 15 %. Measurement uncertainty ± 10 %.

④ Tolerance of expected light flux - 0 % / + 15 %. Measurement uncertainty ± 10 %. Based on calculation.

⑤ Tolerance of power consumption P<sub>on</sub> ± 10 %. Measurement uncertainty ± 5 %.

## ACL LENS 43x280mm

Accessory

**Product description ACL LENS**

- \_ ACL LENS for LLE 24mm HO HV ADV1
- \_ Available with different beam characteristics, light distribution graphics see data sheet 6.2 light distribution
- \_ IP20 ingress protection: Lens, module and endcap assembled together on the luminaire body ensure IP20 ingress protection
- \_ Material: PMMA
- \_ Max. permissible temperature 80 °C

**Product description Endcap**

- \_ ENDCAP for ACL LENS 43x280mm
- \_ Material: PMMA

**Website**

<http://www.tridonic.com/28003576>

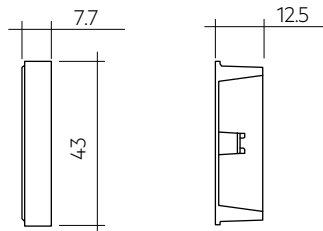
**Ordering data**

Type	Article number	Length L	Beam characteristic	Efficiency	Packaging, bag	Packaging, carton	Weight per pc.
ACL LENS 43 x 280mm 30°	28003576	283.6 mm	30°	92 %	-	56 pc(s).	0.080 kg
ACL LENS 43 x 280mm 60°	28003577	283.6 mm	60°	91 %	-	56 pc(s).	0.070 kg
ACL LENS 43 x 280mm 90°	28003578	283.6 mm	90°	90 %	-	56 pc(s).	0.070 kg
ACL LENS 43 x 280mm ASY	28003579	283.6 mm	asymmetric	87 %	-	56 pc(s).	0.080 kg
ACL LENS 43 x 280mm DASY	28003580	283.6 mm	double asymmetric	88 %	-	56 pc(s).	0.080 kg
ACL ENDCAP 43F	28003581	-	-	-	50 pc(s).	2,100 pc(s).	0.002 kg
ACL ENDCAP 43M	28003582	-	-	-	50 pc(s).	2,100 pc(s).	0.002 kg

## ACL CLIP 4.3mm

Accessory

**Product description**

- \_ Clip for fixation of LED modules with 4.3 mm holes
- \_ Fast snap on mounting (sheet thickness 0.5 – 1.0 mm for PUSH-FIX and 1 – 2 mm for PUSH-FIX Long)
- \_ For drilling hole 4 mm
- \_ Clip made of polycarbonate
- \_ Minimum sales quantity 500 pcs.

**Website**

<http://www.tridonic.com/28001036>

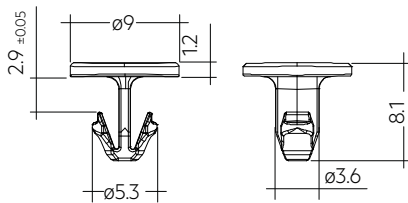
**Ordering data**

Type	Article number	Colour	Packaging, bag <sup>①</sup>	Weight per pc.
ACL CLIP 4.3mm PUSH-FIX	28001036	White	500 pc(s).	0.001 kg
ACL CLIP 4,3mm PUSH-FIX Long	28002314	Transparent	500 pc(s).	0.001 kg

① Minimum sales quantity 500 pcs.

## ACL BRIDGE LLE24/40

Accessory

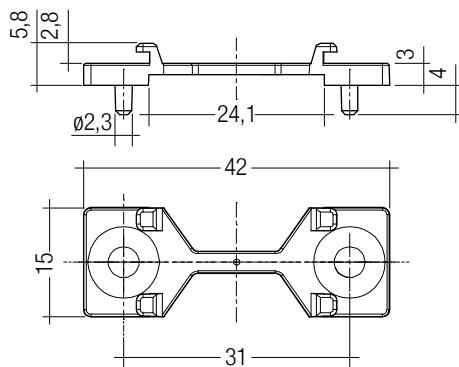
**Product description**

- \_ Enables the fixation of 24 mm wide Tridonic LED modules to fixtures made for 40 mm wide modules
- \_ Ideal for extruded aluminium gear trays made for 40 mm modules with pre-alignment knobs
- \_ Clip-on for LINEAR COVER and LINEAR LENS <sup>①</sup>
- \_ For LLE 24 with 280 mm module minimum 2 bridges required
- \_ For LLE 24 with 560 mm module minimum 3 bridges required
- \_ Fixation via M3 or M4 countersunk screw, max. tightening torque 0.5 Nm
- \_ BRIDGE made of white polycarbonate
- \_ Minimum sales quantity 600 pcs.

<sup>①</sup> Beam characteristics will change due to the elevated fixation (see photometric files for details).

**Website**

<http://www.tridonic.com/28001205>

**Ordering data**

Type	Article number	Colour	Packaging, carton	Weight per pc.
ACL BRIDGE LLE24/40 SCREW-FIX	28001205	White	600 pc(s).	0.001 kg

## 1. Standards

IEC 62031  
IEC 62471  
IEC 61000-4-2  
IEC 62778  
IEC 61547

### 1.1 Photometric code

Key for photometric code, e. g. 830 / 349

1 <sup>st</sup> digit	2 <sup>nd</sup> + 3 <sup>rd</sup> digit	4 <sup>th</sup> digit	5 <sup>th</sup> digit	6 <sup>th</sup> digit	
Code	CRI	Colour temperature in Kelvin x 100	MacAdam initial	MacAdam after 25% of the lifetime (max.6000h)	
				Code	Luminous flux
7	70 – 79			7	≥ 70 %
8	80 – 89			8	≥ 80 %
9	≥90		9	≥ 90 %	

### 1.2 Energy classification

Type	Colour temperature	Forward current	Energy classification	Energy consumption
LLE 24x280mm 1250lm 830 HO HV ADV1	3,000 K	300 mA	C	7 kWh / 1,000 h
LLE 24x280mm 1250lm 840 HO HV ADV1	4,000 K	300 mA	C	7 kWh / 1,000 h
LLE 24x280mm 1250lm 850 HO HV ADV1	6,500 K	300 mA	C	7 kWh / 1,000 h
LLE 24x560mm 2400lm 830 HO HV ADV1	3,000 K	300 mA	C	14 kWh / 1,000 h
LLE 24x560mm 2400lm 840 HO HV ADV1	4,000 K	300 mA	C	14 kWh / 1,000 h
LLE 24x560mm 2400lm 850 HO HV ADV1	6,500 K	300 mA	C	14 kWh / 1,000 h

Energy label and further information at [www.tridonic.com](http://www.tridonic.com) in the certificates tab of the corresponding product page and at the EPREL data base <https://eprel.ec.europa.eu/>

## 2. Thermal details

### 2.1 tc point, ambient temperature and lifetime

The temperature at tp reference point is crucial for the light output and lifetime of a LED product.

For LLE a tp temperature of 50 °C has to be complied in order to achieve an optimum between heat sink requirements, light output and lifetime.

Compliance with the maximum permissible reference temperature at the tc point must be checked under operating conditions in a thermally stable state. The maximum value must be determined under worst-case conditions for the relevant application.

The tc and tp temperature of LED modules from Tridonic are measured at the same reference point.

### 2.2 Storage and humidity

Storage temperature	-40 ... +85 °C
---------------------	----------------

Operation only in non condensing environment.

Humidity during processing of the module should be between 30 to 70 %.

## 2.3 Heat sink values

### LLE 24x280mm 1250lm ADV1

ta	tp	Forward current	R <sub>th, hs-a</sub>	Cooling area
25 °C	50 °C	300 mA	715 K/W	93 cm <sup>2</sup>
25 °C	50 °C	500 mA	3.49 K/W	191 cm <sup>2</sup>
25 °C	50 °C	700 mA	2.05 K/W	325 cm <sup>2</sup>
35 °C	50 °C	300 mA	3.98 K/W	167 cm <sup>2</sup>
35 °C	50 °C	500 mA	1.79 K/W	373 cm <sup>2</sup>
35 °C	50 °C	700 mA	0.93 K/W	718 cm <sup>2</sup>
40 °C	50 °C	300 mA	2.40 K/W	278 cm <sup>2</sup>
40 °C	50 °C	500 mA	0.94 K/W	712 cm <sup>2</sup>
40 °C	50 °C	700 mA	0.37 K/W	1,813 cm <sup>2</sup>
45 °C	50 °C	300 mA	0.81 K/W	818 cm <sup>2</sup>

### LLE 24x560mm 2400lm ADV1

ta	tp	Forward current	R <sub>th, hs-a</sub>	Cooling area
25 °C	50 °C	300 mA	3.58 K/W	186 cm <sup>2</sup>
25 °C	50 °C	500 mA	1.75 K/W	381 cm <sup>2</sup>
25 °C	50 °C	700 mA	1.03 K/W	650 cm <sup>2</sup>
35 °C	50 °C	300 mA	1.99 K/W	335 cm <sup>2</sup>
35 °C	50 °C	500 mA	0.90 K/W	745 cm <sup>2</sup>
35 °C	50 °C	700 mA	0.46 K/W	1,436 cm <sup>2</sup>
40 °C	50 °C	300 mA	1.20 K/W	555 cm <sup>2</sup>
40 °C	50 °C	500 mA	0.47 K/W	1,422 cm <sup>2</sup>
40 °C	50 °C	700 mA	0.18 K/W	3,627 cm <sup>2</sup>
45 °C	50 °C	300 mA	0.41 K/W	1,633 cm <sup>2</sup>

### Notes

The actual cooling surface can differ because of the material, the structural shape, outside influences and the installation situation. Depending on the heat sink a heat conducting paste or heat conducting film might be necessary to keep the specified tp temperature.

### 3. Installation / wiring

#### 3.1 Electrical supply/choice of LED Driver

LLE modules from Tridonic are not protected against overvoltages, overcurrents, overloads or short-circuit currents. Safe and reliable operation can only be guaranteed in conjunction with a LED Driver which complies with the relevant standards. The use of LED Driver from Tridonic in combination with LLE modules guarantees the necessary protection for safe and reliable operation.

If a LED Driver other than Tridonic is used, it must provide the following protection:

- Short-circuit protection
- Overload protection
- Overtemperature protection



LLE modules must be supplied by a constant current LED Driver. Operation with a constant voltage LED Driver will lead to an irreversible damage of the module.

Wrong polarity can damage the LLE.

The LLE module is designed for serial wiring.

LLE can be operated either from SELV LED Drivers or from LED Drivers with LV output voltage.



LLE are basic insulated up to 440 V (if mounted with M4 screws with head diameter 7 mm in combination with plastic washers) against ground and can be mounted directly on earthed metal parts of the luminaire. If the max. output voltage of the LED Driver (also against earth) is above 440 V, an additional insulation between LED module and heat sink is required (for example by insulated thermal pads) or by a suitable luminaire construction.

At voltages > 60 V an additional protection against direct touch (test finger) to the light emitting side of the module has to be guaranteed. This is typically achieved by means of a non removable light distributor over the module.

#### 3.2 Wiring

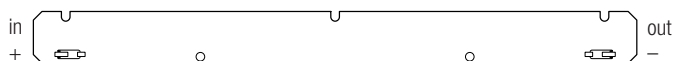

#### Wiring examples for serial wiring

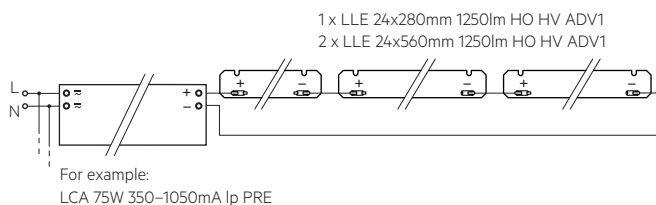
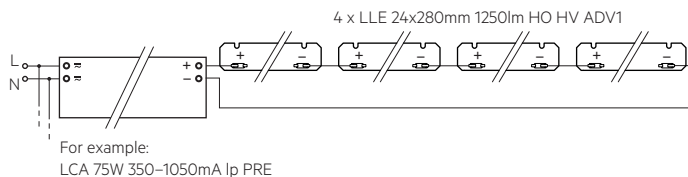

#### 3.3 Wiring type and cross section

The wiring can be in stranded wires or solid with a cross section of 0.2 to 0.75 mm<sup>2</sup>.

For the push-wire connection you have to strip the insulation (8-9 mm).

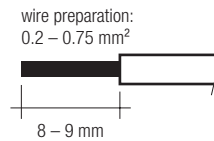

To remove the wires use a suitable tool (e.g. Microcon release pin) or through twist and pull.



### 3.4 Mounting instruction



None of the components of the LLE (substrate, LED, electronic components etc.) may be exposed to tensile or compressive stresses.

Max. torque for fixing: 0.5 Nm.

The LED modules are mounted onto a heat sink with min. 3 screws per module or ACL CLIP 4.3mm.



Chemical substance may harm the LED module. Chemical reactions could lead to colour shift, reduced luminous flux or a total failure of the module caused by corrosion of electrical connections.

Materials which are used in LED applications (e.g. sealings, adhesives) must not produce dissolver gas. They must not be condensation curing based, acetate curing based or contain sulfur, chlorine or phthalate.

Avoid corrosive atmosphere during usage and storage.

### Mounting example 2 x 280 mm or 1 x 560 mm with lens

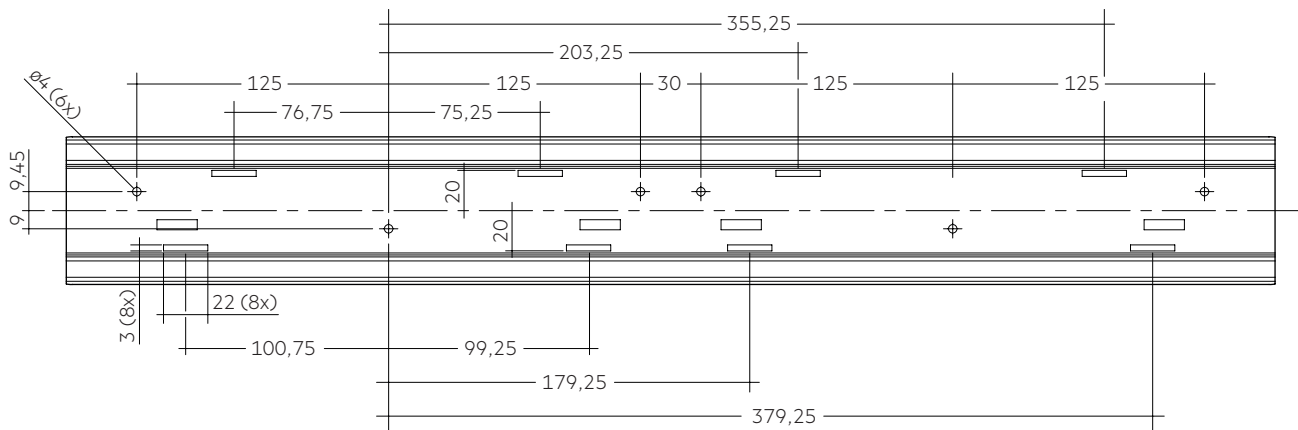

### 3.5 EOS/ESD safety guidelines



The device / module contains components that are sensitive to electrostatic discharge and may only be installed in the factory and on site if appropriate EOS/ESD protection measures have been taken. No special measures need be taken for devices/modules with enclosed casings (contact with the pc board not possible), just normal installation practice. Please note the requirements set out in the document EOS / ESD guidelines (Guideline\_EOS\_ESD.pdf) at: <http://www.tridonic.com/esd-protection>

## 4. Lifetime

### 4.1 Lifetime, lumen maintenance and failure rate

The light output of an LED Module decreases over the lifetime, this is characterized with the L value.

L70 means that the LED module will give 70 % of its initial luminous flux.

This value is always related to the number of operation hours and therefore defines the lifetime of an LED module.

As the L value is a statistical value and the lumen maintenance may vary over the delivered LED modules.

The B value defines the amount of modules which are below the specific L value, e.g. L70B10 means 10 % of the LED modules are below 70 % of the initial luminous flux, respectively 90 % will be above 70 % of the initial value.

In addition the percentage of failed modules (fatal failure) is characterized by the C value.

The F value is the combination of the B and C value. That means for F degradation and complete failures are considered, e.g. L70F10 means 10 % of the LED modules may fail or be below 70 % of the initial luminous flux.

### 4.2 Lumen maintenance for LLE 24mm HO HV ADV1

Forward current	tp tempera- ture	L90 / F10		L80 / F10		L70 / F10	
		L90 / F10	L90 / F50	L80 / F10	L80 / F50	L70 / F10	L70 / F50
200 mA	40 °C	35k h	37k h	>72k h	>72k h	>72k h	>72k h
	45 °C	35k h	37k h	>72k h	>72k h	>72k h	>72k h
	50 °C	35k h	37k h	>72k h	>72k h	>72k h	>72k h
	55 °C	32k h	34k h	64k h	68k h	>72k h	>72k h
	60 °C	28k h	30k h	60k h	63k h	>72k h	>72k h
	65 °C	28k h	30k h	60k h	63k h	>72k h	>72k h
	70 °C	28k h	30k h	60k h	63k h	>72k h	>72k h
	75 °C	28k h	30k h	60k h	63k h	>72k h	>72k h
	80 °C	28k h	30k h	60k h	63k h	>72k h	>72k h
	85 °C	26k h	28k h	60k h	59k h	>72k h	>72k h
300 mA	40 °C	33k h	35k h	69k h	>72k h	>72k h	>72k h
	45 °C	33k h	35k h	69k h	>72k h	>72k h	>72k h
	50 °C	33k h	35k h	69k h	>72k h	>72k h	>72k h
	55 °C	31k h	32k h	64k h	66k h	>72k h	>72k h
	60 °C	28k h	29k h	59k h	60k h	>72k h	>72k h
	65 °C	28k h	29k h	59k h	60k h	>72k h	>72k h
	70 °C	28k h	29k h	59k h	60k h	>72k h	>72k h
	75 °C	28k h	29k h	59k h	60k h	>72k h	>72k h
	80 °C	28k h	29k h	59k h	60k h	>72k h	>72k h
	85 °C	26k h	27k h	54k h	57k h	>72k h	>72k h
500 mA	40 °C	33k h	35k h	69k h	>72k h	>72k h	>72k h
	45 °C	33k h	35k h	69k h	>72k h	>72k h	>72k h
	50 °C	33k h	35k h	69k h	>72k h	>72k h	>72k h
	55 °C	30k h	32k h	63k h	67k h	>72k h	>72k h
	60 °C	26k h	29k h	56k h	60k h	>72k h	>72k h
	65 °C	26k h	29k h	56k h	60k h	>72k h	>72k h
	70 °C	26k h	29k h	56k h	60k h	>72k h	>72k h
	75 °C	26k h	29k h	56k h	60k h	>72k h	>72k h
	80 °C	26k h	29k h	56k h	60k h	>72k h	>72k h
	85 °C	24k h	27k h	52k h	56k h	>72k h	>72k h
700 mA	40 °C	33k h	35k h	69k h	>72k h	>72k h	>72k h
	45 °C	33k h	35k h	69k h	>72k h	>72k h	>72k h
	50 °C	33k h	35k h	69k h	>72k h	>72k h	>72k h
	55 °C	29k h	32k h	62k h	66k h	>72k h	>72k h
	60 °C	26k h	29k h	55k h	60k h	>72k h	>72k h
	65 °C	26k h	29k h	55k h	60k h	>72k h	>72k h
	70 °C	26k h	29k h	55k h	60k h	>72k h	>72k h
	75 °C	26k h	29k h	55k h	60k h	>72k h	>72k h
	80 °C	26k h	29k h	55k h	60k h	>72k h	>72k h
	85 °C	24k h	26k h	50k h	55k h	>72k h	>72k h

### 4.3 Switching capability

100,000 cycles

Tridonic test according to IEC 62717 Cl 10.3.3

30 s on / 30 s off at I<sub>max</sub>

## 5. Electrical values

### 5.1 Declaration of electrical parameters

I<sub>rated</sub> ... Nominal operating current the module is designed for.

I<sub>max</sub> ... Max. permissible continuous operating current incl. The tolerances of the LED driver.

Max. permissible LF current ripple ... Max. output current of the LED driver incl. Tolerances and LF current ripple must not exceed this value.

Max. permissible peak current ... The max. output peak current of the LED driver must not exceed this value.

### 5.2 Typ. forward voltage vs. forward current

LLE 24x280mm 1250lm 8xx HO HV ADV

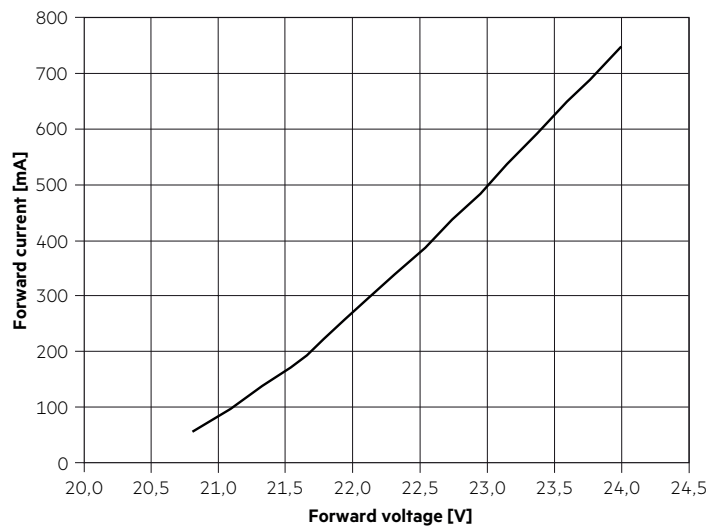

LLE 24x560mm 2400lm 8xx HO HV ADV1

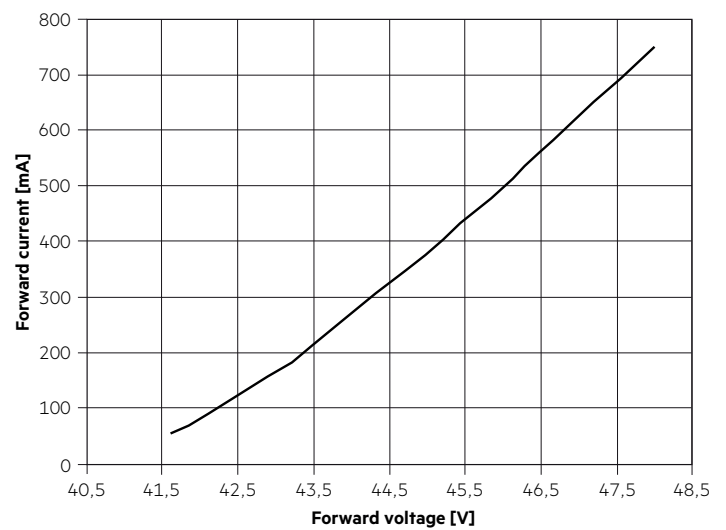

The diagrams are based on statistic values.  
The real values can be different.

### 5.3 Forward voltage vs. tc temperature

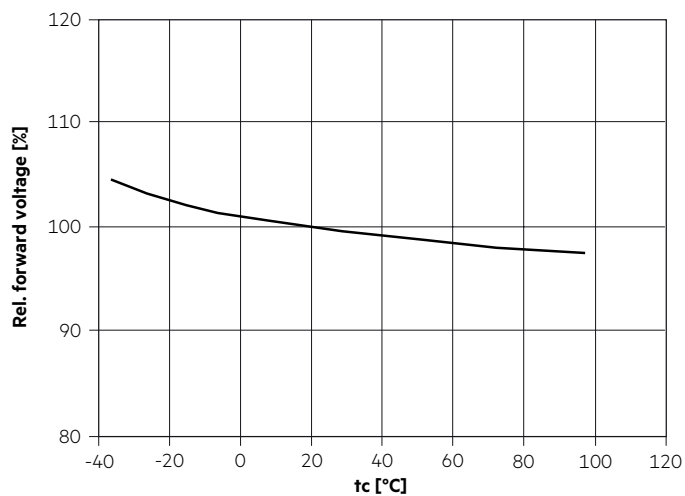

The diagrams are based on statistic values.  
The real values can be different.

## 6. Photometric characteristics

### 6.1 Coordinates and tolerances according to CIE 1931

The specified colour coordinates are integral measured by current impulse of 450 mA and a duration of 100 ms.  
 The ambient temperature of the measurement is  $t_a = 25^\circ\text{C}$ .  
 The measurement tolerance of the colour coordinates are  $\pm 0.01$ .

#### 3,000 K

	x0	y0
Centre	0.4339	0.4032

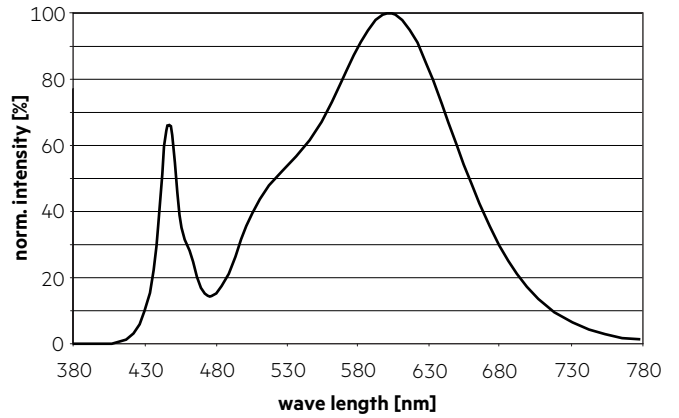
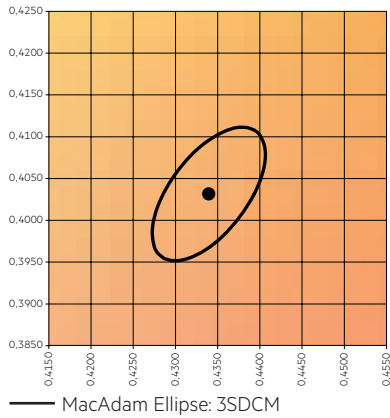

#### 4,000 K

	x0	y0
Center	0.3818	0.3796

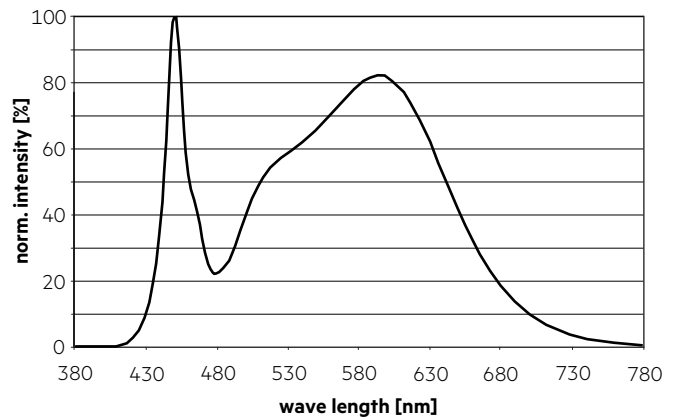
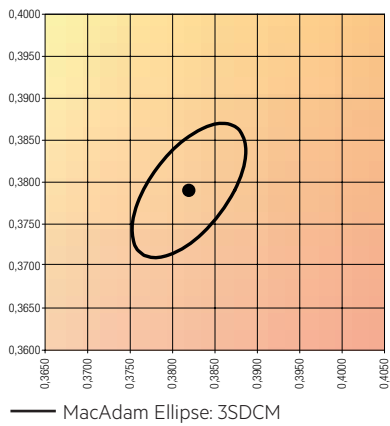

#### 5,000 K

	x0	y0
Center	0.3446	0.3551

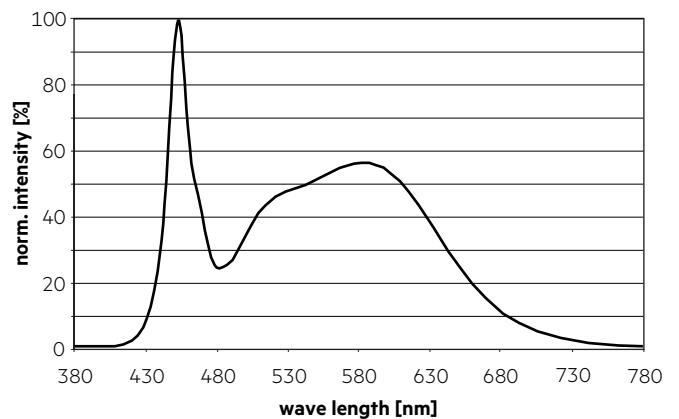
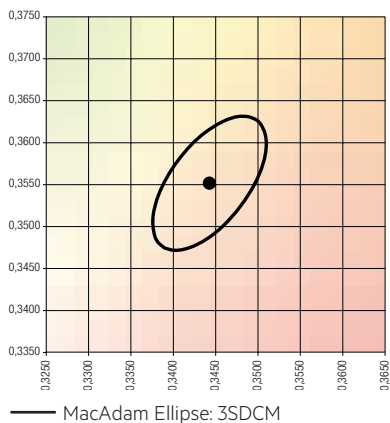

6.2 Light distribution

The optical design of the LLE product line ensures optimum homogeneity for the light distribution.

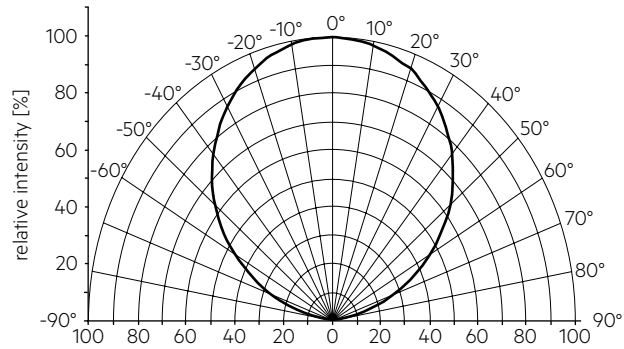

**!** The colour temperature is measured integral over the complete module. The single LED light points can have deviations in the colour coordinates within MacAdam 5. To ensure an ideal mixture of colours and a homogeneous light distribution a suitable optic (e. g. PMMA diffuser) and a sufficient spacing between module and optic (typ. 4 cm) should be used.

ACL LENS 43x280mm 60°

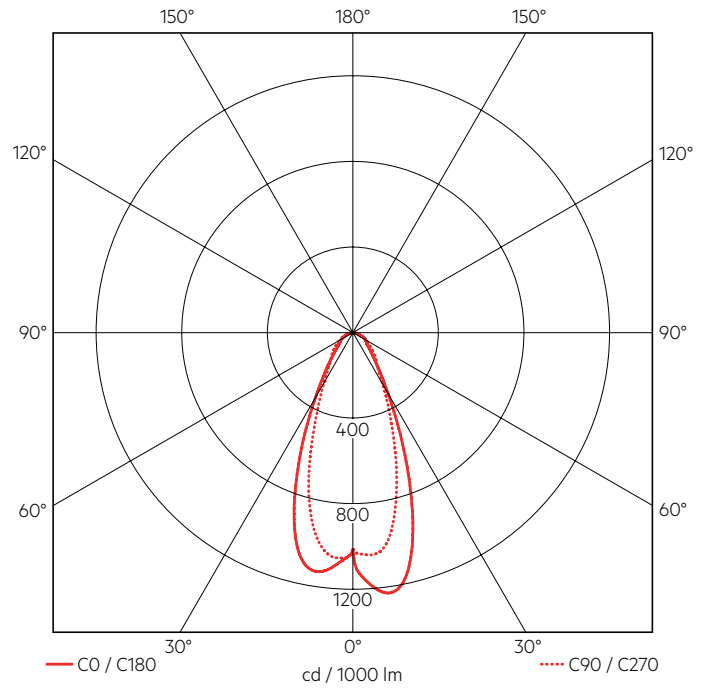

ACL LENS 43x280mm 30°

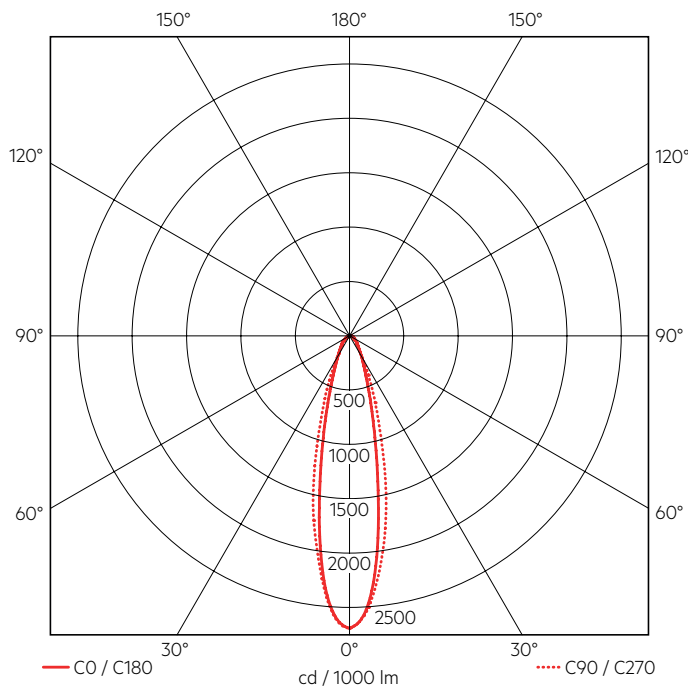

ACL LENS 43x280mm 90°

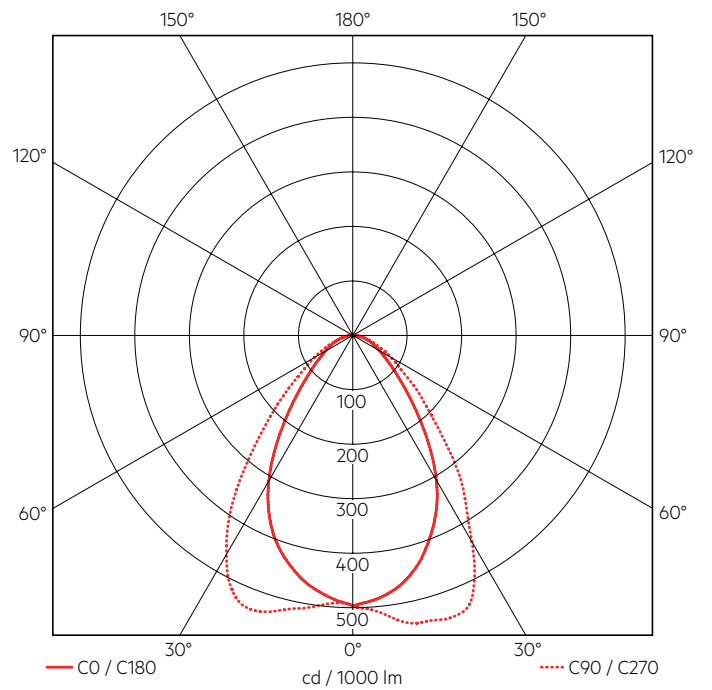

ACL LENS 43x280mm ASY

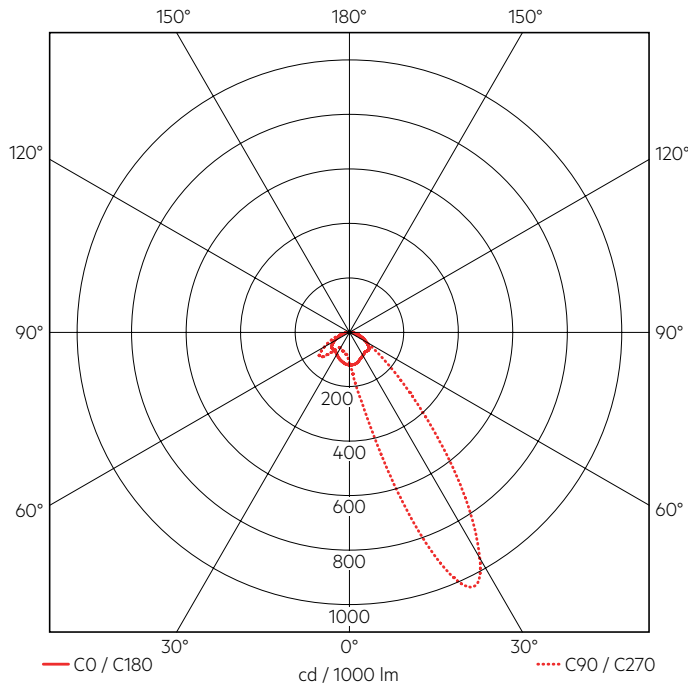

ACL LENS 43x280mm DASY

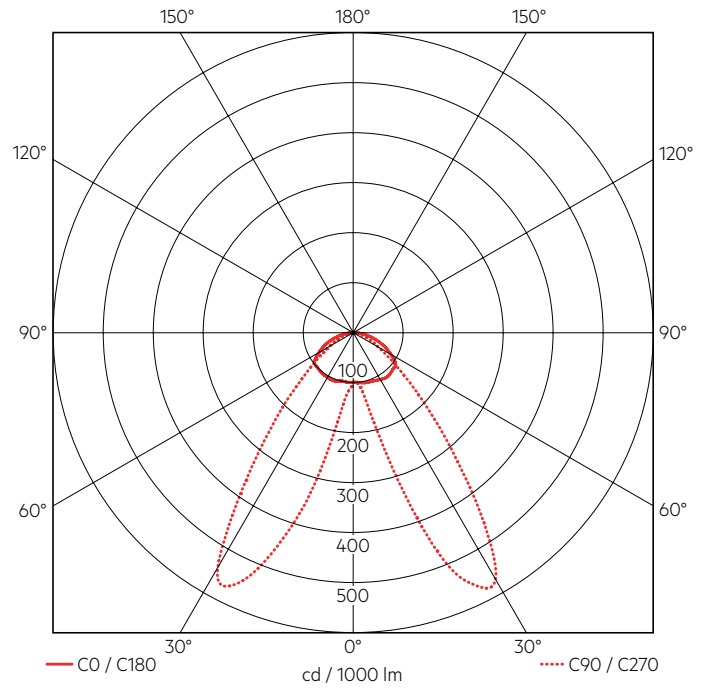

6.3 Relative luminous flux vs. tc temperature

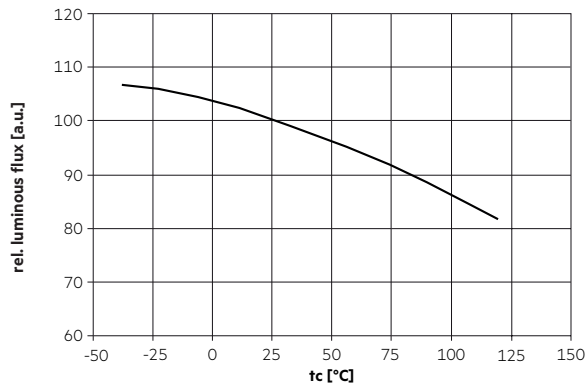

6.4 Relative luminous flux vs. operating current

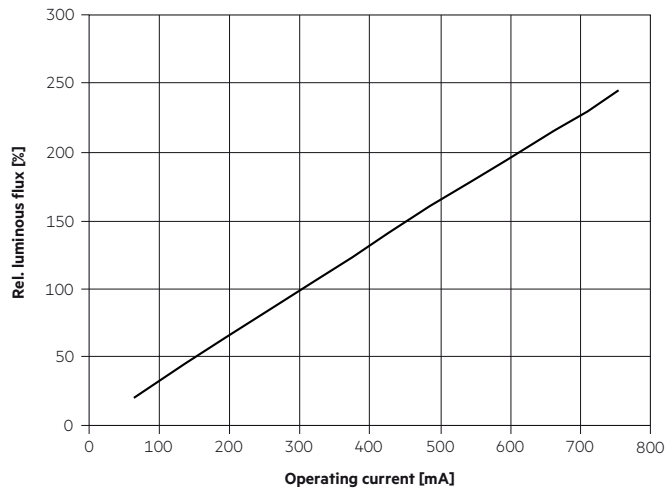

The diagrams are based on statistic values.  
The real values can be different.

7. Miscellaneous

7.1 Additional information

Additional technical information at [www.tridonic.com](http://www.tridonic.com) → Technical Data

Guarantee conditions at [www.tridonic.com](http://www.tridonic.com) → Services

Lifetime declarations are informative and represent no warranty claim.