

Highlights

- Ready-to-connect flexible LED-strip with High Density and Efficiency – HDE
- Ultra-High color rendering index CRI > 90
- Excellent white color consistency MacAdam SDCM ≤3
- Short pitch with 140 LEDs per meter – ideal for homogenous lighting at close distances
- Constant Current Driven IC for professional lighting applications
- Perfect for shelf and accent lighting, e.g. slim linear profiles with opal cover
- Reflective white copper PCB for optimal system efficiency
- High quality adhesive 3M-tape on backside for easy mounting on clean surface or cooling profile
- Long lifetime: L70 = 50.000h ①

Applications

- Shelf Lighting
- Indirect Lighting
- Cove Lighting
- Accent Lighting

Electrical Properties

- Supplied with constant voltage 24 VDC
- Stable photometrics in combination with wide input voltage range 24-26 VDC
- Connect up to 10 meters in series ⑥
- Optimized for high resolution dimming 0,1-100% using Tridonic, welight and feno digital drivers controlled via switchDIM, DSI, DALI or DMX.

Standards

→ page 2

Accessories/Options

- Outdoor version IP65 with silicon casing
- Aluminum profiles for linear and corner applications
- Wide variety of lenses and covers 15°/30°/60°/120°/Asymmetric/Batwing
- Fixed or adjustable mounting brackets
- Large selection of drivers and dimmers and control systems to fit every need and application

→ page 4

Mounting Instructions

→ page 6

Type	Article Code	Supply Voltage (VDC) ③	Color (K)	Photometric Code ⑤	Typ. Data per meter ① ②				Pitch Distance (P)	Cutting Length (C)	LxWxH (mm)	Energy Class (EEI)	Operating temp (°C) ④
					Luminous flux (lm)	Current (mA)	Power (W)	LED quantity					
LEDtape 927 700 HDE G3	W1004-927-G3	24	2700	927 / 349	690	313	7,5	140	7 mm	50 mm	5000x10x2	A+	-35 °C +50 °C
LEDtape 927 700 HDE IP G3	W1004-927-IP-G3	24	2700	927 / 349	655	313	7,5	140	7 mm	50 mm	5020x14x6	A+	-35 °C +35 °C
LEDtape 930 700 HDE G3	W1004-930-G3	24	3000	930 / 349	728	313	7,5	140	7 mm	50 mm	5000x10x2	A+	-35 °C +50 °C
LEDtape 930 700 HDE IP G3	W1004-930-IP-G3	24	3000	930 / 349	692	313	7,5	140	7 mm	50 mm	5020x14x6	A+	-35 °C +35 °C
LEDtape 940 700 HDE G3	W1004-940-G3	24	4000	940 / 349	766	313	7,5	140	7 mm	50 mm	5000x10x2	A+	-35 °C +50 °C
LEDtape 940 700 HDE IP G3	W1004-940-IP-G3	24	4000	940 / 349	728	313	7,5	140	7 mm	50 mm	5020x14x6	A+	-35 °C +35 °C
LEDtape 965 700 HDE G3	W1004-965-G3	24	6500	965 / 349	766	313	7,5	140	7 mm	50 mm	5000x10x2	A+	-35 °C +50 °C
LEDtape 965 700 HDE IP G3	W1004-965-IP-G3	24	6500	965 / 349	728	313	7,5	140	7 mm	50 mm	5020x14x6	A+	-35 °C +35 °C

① All values for ta = 25 °C / tc = 65 °C

② Tolerance range for electrical and optical data ±10%

③ Exceeding the maximum operating voltage leads to an overload on the tape. This may result in a significant reduction in lifetime or even destruction of the tape. Tolerance range for the supply voltage 24V: +2V / -0V

④ Self-cooling at ta ≤ 35 °C

⑤ According to IEC 62717

⑥ When connecting 10 meter in series, the supply voltage must be between 24-26V at the beginning of the tape. Lower voltage can cause a significant reduction in light output at the end of length.

Standards

- IEC 62031
- IEC 62471
- IEC 62717
- IEC 6100-4-2
- IEC 62717

Thermal behavior

Storage Temperature	-30/+65 °C
Operating Temperature	-35/+35/+50 °C
Tc max	75 °C

Relative luminous flux vs. ambient temperature

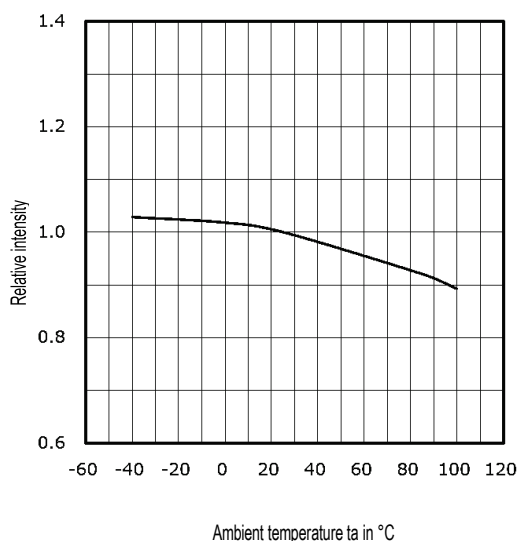

⚠ Thermal design and heat sink

The rated life of LED-products depends to a large extent on the temperature. Welight's excellent thermal design for the LEDtape products provides the lowest thermal resistance and therefore allowing new compact designs without sacrificing quality, safety and life time. However, if the permissible temperature limits are exceeded, the life of the LEDtape will be greatly reduced or the LEDtape may be destroyed.

It might be necessary to mount the LEDtape onto a heat sink, e.g. an aluminum profile. The size of the heat sink is largely depending on the ambient temperature (t_a) of the application. The following tables should be seen as a guide to a recommended heat sink depending on different t_a :

LEDtape 700 HDE (per meter)

Ambient Temperature (T_a)	Reference Temperature (T_c)	Cooling Area (cm^2)	Thermal Resistance R_{thS-A}	Recommended Aluminum profile
25 °C	65 °C	Self-cooling	Self-cooling	Optional
35 °C	65 °C	Self-cooling	Self-cooling	Optional
45 °C	65 °C	300	2,1 KW	Z200-2 / Z201-2 / Z22W-2
50 °C	65 °C	400	1,8 KW	Z22W-2

LEDtape 700 HDE IP65 (per meter)

Ambient Temperature (T_a)	Reference Temperature (T_c)	Cooling Area (cm^2)	Thermal Resistance R_{thS-A}	Recommended Aluminum profile
25 °C	65 °C	Self-cooling	Self-cooling	Optional
35 °C	65 °C	Self-cooling	Self-cooling	Optional
>35 °C	Not allowed	-	-	-

The temperature at t_c reference point is crucial for the light output and life time of an LEDtape. For the welight LEDtape a t_c temperature of 65 °C is recommended in order to achieve an optimum between heat sink requirements, light output and life time.

Life time, lumen maintenance and failure fraction

The light output of the LEDs on the tape decreases over the life-time, this is characterized with the L value. L70 means that the LEDtape will give 70 % of its initial luminous flux. This value is always related to the number of operation hours and therefore defines the lifetime of the LEDs.

The L value is a statistical value and the lumen maintenance may vary over the delivered LEDtape. The B value defines the amount of LEDs which are below the specific L value, e.g. L70B10 means 10 % of the LEDs are below 70 % of the initial luminous flux, respectively 90 % will be above 70 % of the initial value.

In addition the percentage of failed LEDs (fatal failure) is characterized by the C value. The F value is the combination of the B and C value. That means for F degradation and complete failures are considered, e.g. L70F10 means 10 % of the LEDs on the tape may fail or be below 70 % of the initial luminous flux.

Type	Reference Temperature (T_c)	L90F10	L70F10
LEDtape 700 HDE	65°C	24 000 h	>50 000 h
	75°C	12 000 h	36 000 h
LEDtape 700 HDE IP65	65°C	20 000 h	>50 000 h
	75°C	10 000 h	32 000 h

⚠ The temperature on the surface of the LEDtape (t_c) may under no circumstances be higher than 65 °C if the expected lifetime of the LEDtape is to be met.

Compliance with the maximum permissible reference temperature at the t_c point must be checked under operating conditions in a thermally stable state. The maximum value must be determined under worst-case conditions for the relevant application.

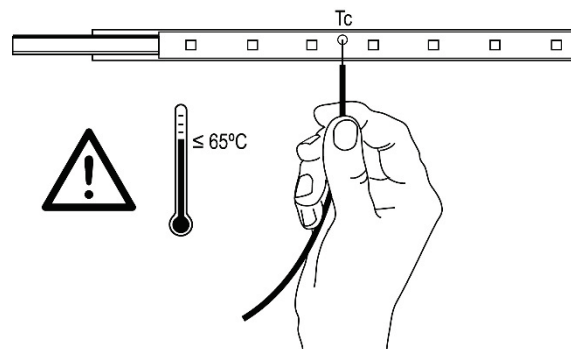

Light Distribution

Radiance Angle = 120°

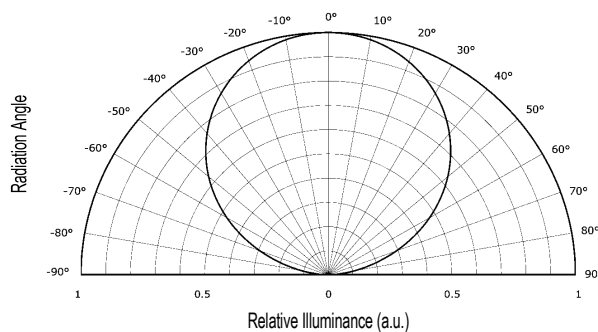

Photometric Code (according to EN 62717)

1 st digit		2nd + 3rd digit	4th digit	5th digit	6th digit	
Code	CRI	Color temperature in Kelvin x 100	Initial MacAdam ellipse SDCM	Maintained MacAdam ellipse SDCM after 25% of the lifetime (6000 h)	Lumen maintenance after 25% of the lifetime (6000 h)	
					Code	Light Output
7	67 – 76				7	≥ 70 %
8	77 – 86				8	≥ 80 %
9	87 – ≥90			9	≥ 90 %	

Chromaticity coordinates and tolerances (according to CIE 1931)

White Tone	CCT	Photometric Code
Incandescent	2700 K	927 / 349
Warm	3000 K	930 / 349
Neutral	4000 K	940 / 349
Cool	6500 K	965 / 349

The specified color coordinates are measured by a current impulse with nominal values of module after a settling time of 100 msec. The ambient temperature of the measurement is $t_a = 25\text{ }^\circ\text{C}$. The measurement tolerance of the color coordinates are ± 0.01 .

2700 K	x0	y0
Centre	0,4630	0,4200

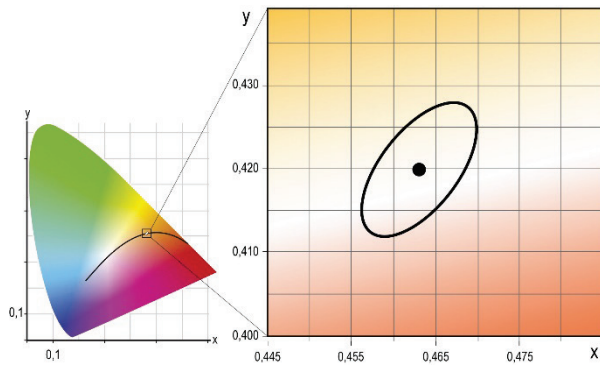

MacAdam ellipse: 3 SDCM

3000 K	x0	y0
Centre	0,4400	0,4030

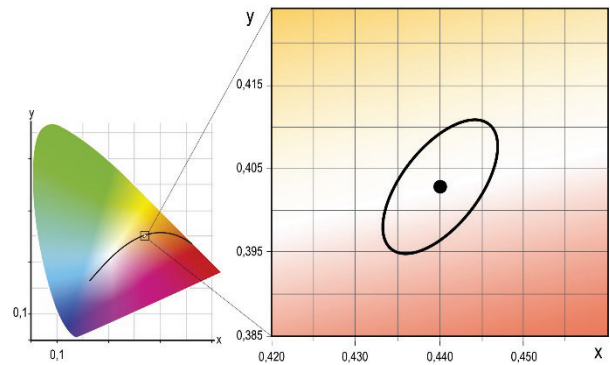

MacAdam ellipse: 3 SDCM

4000 K	x0	y0
Centre	0,3800	0,3800

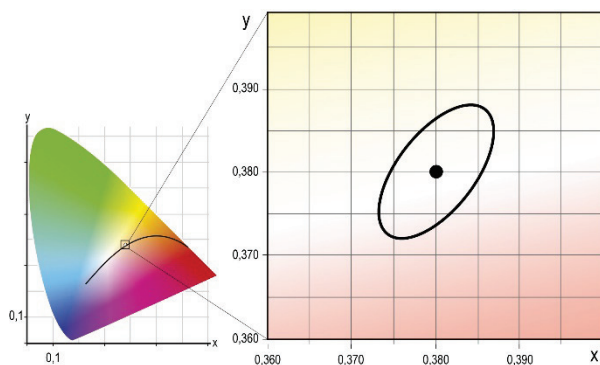

MacAdam ellipse: 3 SDCM

6500 K	x0	y0
Centre	0,3130	0,3370

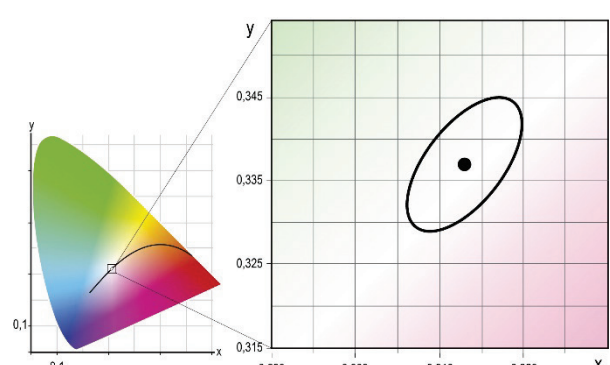

MacAdam ellipse: 3 SDCM

ACCESSORIES

Cable & Connection accessories

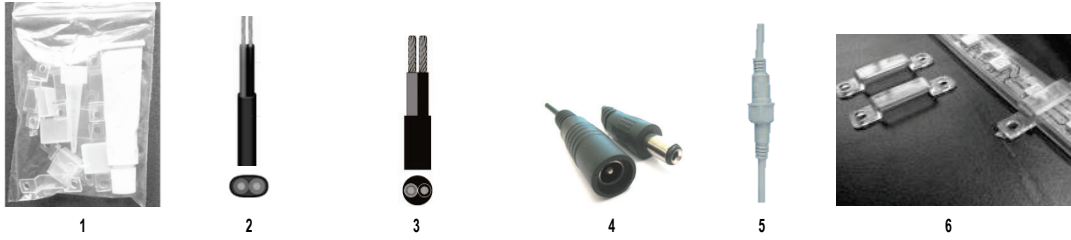

	Type	Art. Code	Description	LEDtape	
				IP20	IP65
1	LEDTape Accessory IP Assembly Kit 10	W8901	5 End Caps, 10 Mounting Brackets & Silicon (one kit is included on delivery)	○	●
2	LEDTape Accessory LED Cable 100m Indoor	W8407	H03VVH 2X0.75 Rd/Bl, White Insulation, 100 m	●	○
3	LEDTape Accessory LED Cable 100m Outdoor	RKKB2X1	RKKB 2X1 Rd/Bl Yd 5,8mm Black Insulation 100 m	○	●
4	LEDTape Accessory CON IP20 kit F+M	W8412-A1	Quick Connector kit with female and male plug including 30 cm cable, black	●	○
5	LEDTape Accessory CON IP68 kit F+M	W8411-A2	Quick Connector kit with female and male plug including 30 cm cable, white	○	●
6	LEDTape Accessory IP Clips 100-pack	W8902	Plastic mounting clips for all IP65-rated LEDTapes, 100 pcs per bag.	○	●

Drivers & Dimmers

(a) Select the way you want to dim your system and (b) chose a driver that matches your LED-power.



(a)	Control Signal	Dimmer Type	Art. Code	Max length per dimmer	Multiple dimmers allowed
1	switchDIM (phase impulse)	weight LEDcontrol 2x10A	W7003	2 x 30 meter	Yes (max 25)
1	DALI	weight LEDcontrol 2x10A	W7003	2 x 30 meter	Yes
2	one4all integrated ①②	Tridonic LCA one4all PRE	28001253	13 meter	Yes
3	one4all integrated ①②	Tridonic K210	86455937	3 meter	Yes
4	1-10V	fenof analog 1-24e	00000066	19 meter	Yes
5	DMX	fenof dmx 1-24e	00002100	19 meter	Yes
6	IP44 Dimmer Protection Kit	Type 3-5 above	24138842	-	-

① one4all supports ready2mains, corridorFUNCTION, switchDIM (dimming via phase impulse), DSI and DALI in the same dimmer.

② The dimmer has an integrated LED-driver and cannot be used together with external LED-driver in table (b).

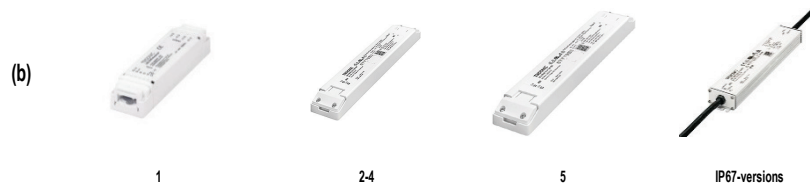

(b)	Power	Driver	IP20 Art. Code	IP67 Art. Code
1	25 W	Tridonic LCU 25W 24V	28000849	-
2	35 W	Tridonic LCU 35W 24V EXC	28000411	-
3	60 W	Tridonic LCU 60W 24V EXC	28000412	28000512
4	96 W	Tridonic LCU 96W 24V EXC	28000413	28000513
5	180 W	Tridonic LCU 180W 24V EXC	28000414	28000514

LED-drivers <25 W available on request. Please contact us at info@weight.se for information about suitable end-user control interfaces, e.g. touch panels, color mixing software, potentiometers, push-buttons, etc.

Aluminum Profile Systems & Lenses

Start by selecting an aluminum profile (a) and a suitable lens cover (b) and then add optional accessories (c).

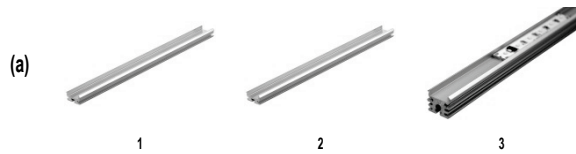

(a)	Type	Art. Code	L (mm)	W (mm)	H (mm)	W (mm) incl. lens cover	H (mm) incl. lens cover	Application	Optional accessories			
									Lens Cover	End Cap	Fixed Mount	Adjustable Mount
1	Z200-2	24166148	2000	18	9	21	16	Corner	●	○	○	○
2	Z201-2	24166149	2000	18	9	21	16	Linear Slim	●	●	●	○
3	Z22W-2	24166150	2000	18	16	21	24	Linear	●	●	●	●

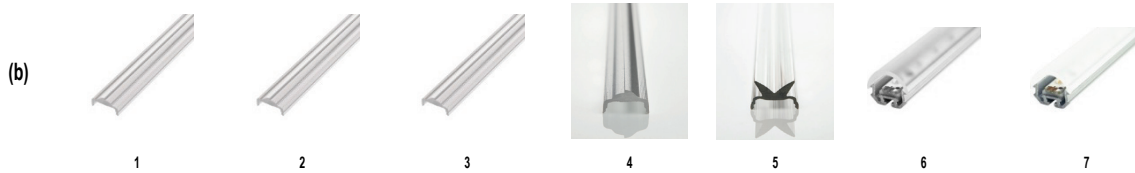

(b)	Type	Art. Code	L (mm)	Typ. application	Profile		
					Z200-2	Z201-2	Z22W-2
1	15°	24166409	2000	Wall wash	●	●	●
2	30°	24166410	2000	Wall wash	●	●	●
3	60°	24166411	2000	Shelf	●	●	●
4	30° x 60°	24166412	2020	Asymmetric	●	●	●
5	Batwing	24166120	2000	Side-emitting	●	●	●
6	120°	24138737	2000	Accent	●	●	●
7	120° opal	24138736	2000	Lines	●	●	●

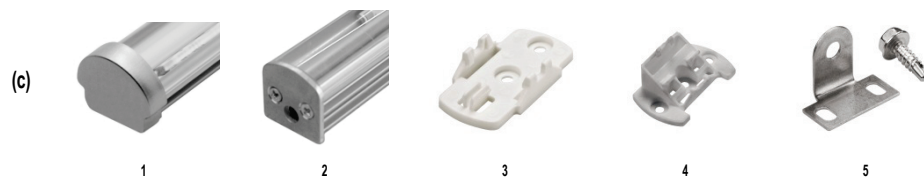

(c)	Type	Art. Code	Profile		
			Z200-2	Z201-2	Z22W-2
1	End cap Grey PMMA	24166334	○	●	○
2	End Cap Aluminum	24139174	○	○	●
2	End Cap Aluminum Cable Entry	24139173	○	○	●
3	Mounting Bracket 0°	88166859	○	●	●
4	Mounting Bracket 15°	88167372	○	●	●
4	Mounting Bracket 30°	88167373	○	●	●
4	Mounting Bracket 45°	88167374	○	●	●
4	Mounting Bracket 60°	88167375	○	●	●
5	Mounting Bracket Adjustable	24166024	○	○	●

 We also have complete profile systems for IP66 protection for demanding outdoor environments. Please contact us for further details.

LEDtape Indoor & Outdoor Series IP00/IP65

INSTRUKTIONER
 INSTRUCTIONS
 ANLEITUNG
 ISTRUZIONI
 INSTRUCCIONES

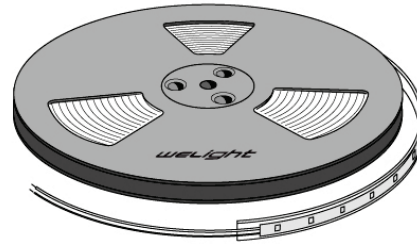

1.

Never bend the LEDtape at a radius smaller than 50 mm.

2.

Assembly must not damage or destroy conducting paths on the circuit board.

3.

The LED-tape is separable at every 4, 6 or 7 LEDs (depending on type) or multiple thereof with the full function of each LED segment. It is only allowed to cut the LED-tape at the indicated cutting line.

4.

Always cut the LEDtape in a straight line – 90 degrees in relation to the PCB edges. Failure to do so can result in damage of the internal conducting paths. It is recommended to use welight's official connection accessories to split, connect, bridge and re-seal the LED-tape.

5.

If you need to cut the LEDtape, re-join the supply cables to the strip by soldering. Please do not reverse polarity. Pre-tin the cables only. Soldering temperature max 300 °C during 4 seconds.

6.

The fixing/cooling surface must be properly cleaned to remove grease, dirt and silicon before application, e.g. using Isopropyl alcohol.

7.

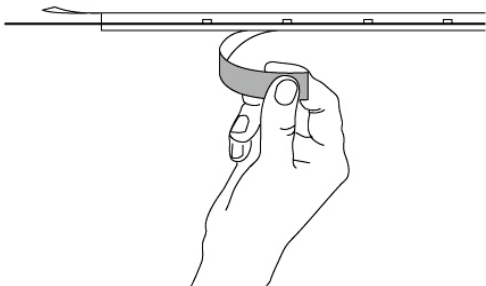

Remove the adhesive tape from the backside of the PCB and fix the LEDtape on the cleaned fixing/cooling surface.

8.

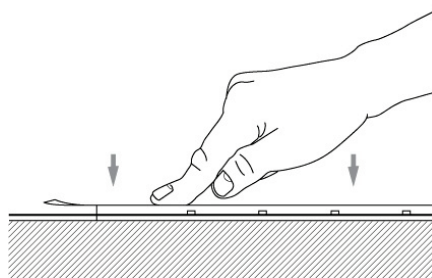

When fixing the LED-tape to a surface, apply an even but gentle pressure and try to avoid applying pressure directly on the LED itself (the maximum allowed pressure is 20 N/cm²).

After assembly always check that the entire length of the tape has attached properly to the surface and that there is no air pockets underneath the PCB.

9.

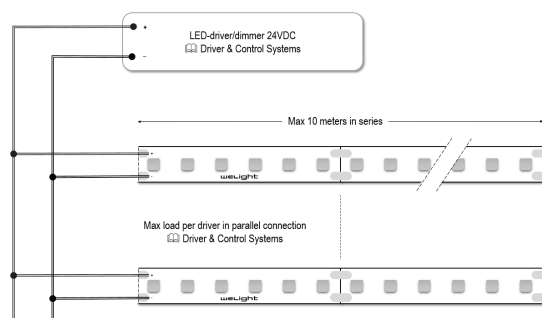

Each reel of LED-tape is delivered with colour coded connection cable L=350mm. Please take care about the polarity (+) Red and (-) Black. Do not connect more than 10 meters of the LED-tape in series.

When connecting several sections in parallel please refer to the datasheet for the allowed total length connected to one controller/dimmer.

10.

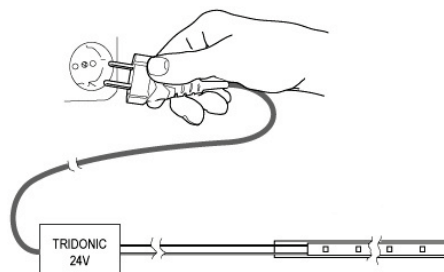

In order to drive welight LED-tapes safely, it is absolutely necessary to operate them with an electronically stabilized power supply protecting against short circuits, overload and overheating. Always use our approved drivers and controls to power the LEDtape – refer to Driver & Control Systems section in the datasheet.

If the wrong type of driver is used the product warranty is void.

11.

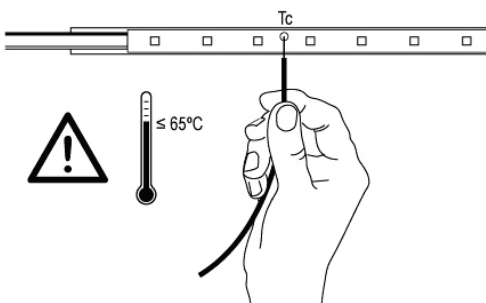

The temperature on the surface of the LEDtape (t_c) may under no circumstances be higher than 65 °C if the expected lifetime of the LEDtape is to be met.

Compliance with the maximum permissible reference temperature at the t_c point must be checked under operating conditions in a thermally stable state. The maximum value must be determined under worst-case conditions for the relevant application.

LEDtape Outdoor Series IP65

TILLKOMMANDE INSTRUKTIONER
ADDITIONAL INSTRUCTIONS
ZUSÄTZLICHE ANLEITUNGEN
INSTRUCTIONS SUPPLÉMENTAIRES
ULTERIORI ISTRUZIONI
INSTRUCCIONES ADICIONAL

12.



Locate the accessories bag located inside the LEDtape IP65 box.

13.

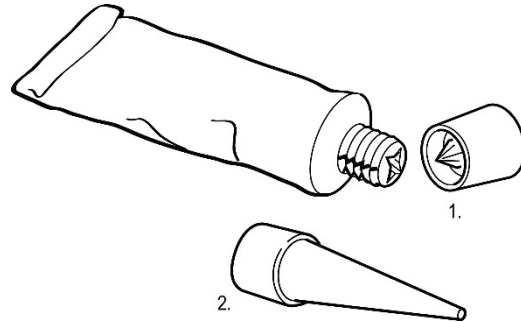

Twist the cap of the silicon tube in the accessories bag. Puncture the seal of the tube using the backside of the tube cap. Screw the dispersion needle onto the tube. Cut the top of the needle at an angle of 45-60 degrees.

14.

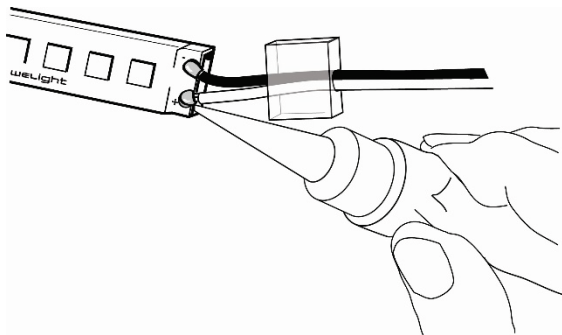

Dispense the silicone inside the open end of the LEDtape.

15.

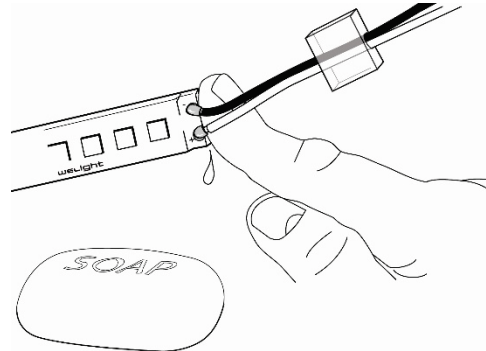

Then use your finger dipped in soapy water to smoothen out the opening creating a solid wall of silicon.

16.

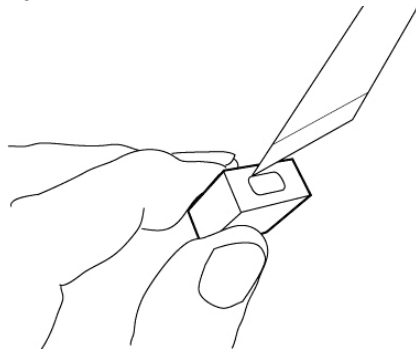

Using a sharp knife or blade, make a small hole in the end cap.

17.

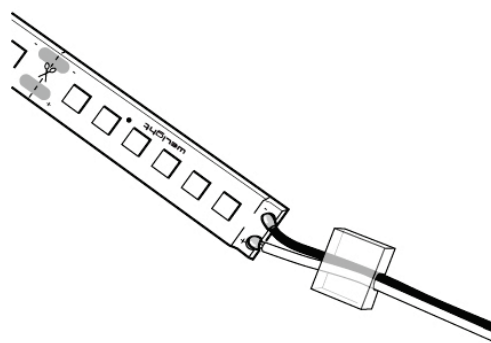

Thread the connection cable through the hole of the end cap.

18.

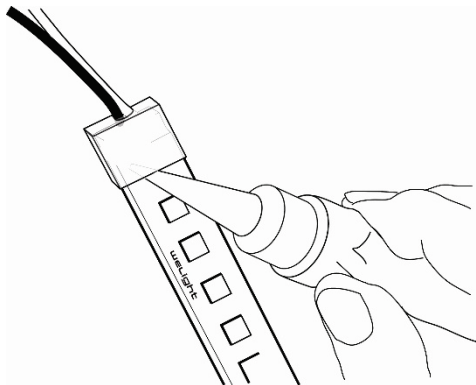

Dispense a small portion of silicone inside the end cap and then slide it into place over the end of the LEDtape. Please wait 60 minutes for the silicone to solidify.

19.

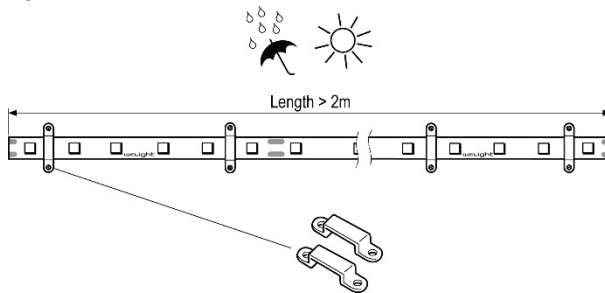

If the operating length is longer than 2 meters or when used in environments with large variations in temperature (e.g. outdoor applications) it is recommended to use the included screw mounting clips in addition to the adhesive tape.

20.

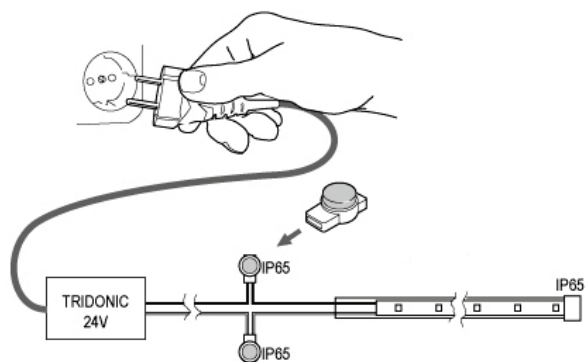

Before you connect the power supply, make sure all cable connections have been properly sealed using weather proof connectors, e.g. 3M Scotchlok (not included).

In order to drive weight LED-tapes safely, it is absolutely necessary to operate them with an electronically stabilized power supply protecting against short circuits, overload and overheating. Always use our approved drivers and controls to power the LEDtape – refer to Driver & Control Systems section in the datasheet.

If the wrong type of driver is used the product warranty is void.

21.

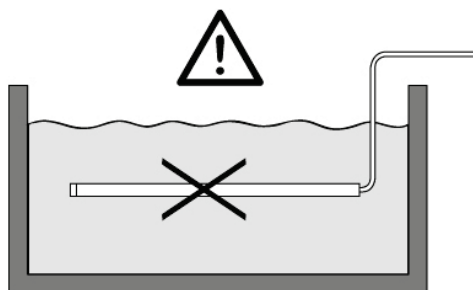

All of weight's outdoor LEDtapes are IP65 certified. This means they can withstand low-pressure pouring or running water for longer periods of time, e.g. rain.

Never install the LEDtape in such a way that it can be submerged in water as it will penetrate the silicon casing and the warranty will be void.

SAFETY INSTRUCTIONS

- EN** Read these instructions carefully before starting the installation and save for future reference. All connections to the device must be made by a qualified electrician or person with the necessary expertise in electrical installation in accordance with relevant rules and standards. Make sure that the mains voltage is disconnected before installation or maintenance.
- SE** Läs dessa instruktioner innan installationen påbörjas och lämna dem vidare till brukaren av anläggningen. All anslutning till enheten får endast utföras av behörig elektriker eller person med kännedom om elektrisk installation i enlighet med gällande regler och standard. Se till att spänningen är frånslagen före installation eller underhåll.
- FI** Lue nämä ohjeet ennen asentamista ja luovuta ohjeet valaisimen seuraavalle käyttäjälle. Kytkenät ohjaimen saa tehdä ainoastaan pätevä sähköasentaja tai sähköasennukset hallitseva henkilö voimassa olevien määräysten ja standardien mukaisesti. Varmista, että jännite on kytketty päältä ennen asennusta ja huoltoa.
- NO** Les disse instruksjonene før du starter installeringen, og gi den deretter videre til anleggets bruker. All tilkobling til enheten skal utføres av godkjent elektriker eller person med nødvendig kunnskap om elektrisk installasjon i henhold til gjeldende forskrifter og standard. Sørg for at strømmen er koblet fra før installering og ved vedlikehold.
- DK** Læs disse anvisninger før du starter installationen og aflever vejledningen til anlæggets bruger. Alle tilslutninger på enheden skal udføres af en autoriseret elinstallatør i overensstemmelse med gældende regler og standarder. Afbryd spænding før installation og vedligeholdelse.