



Module LLE G3 16x140mm 650lm ADV,

LLE G3 16x280mm 1250lm ADV

Modules LLE

Product description

- Ideal for compact linear luminaires designs
- Homogenous illumination thanks to small package distance
- Best refurbishment option for T5 lamps
- Luminous flux range 555 up to 1,620 lm
- LED system solution with outstanding system efficacy up to 132 lm/W, consisting of linear LED modules and LED Driver LCI 65W 150–400mA TOP Ip
- Efficacy of the module up to 142 lm/W
- High colour rendering index CRI > 80
- Small colour tolerance MacAdam 3[®]
- Small luminous flux tolerances
- Colour temperatures 3,000 K and 4,000 K
- Perfectly uniform light, even if several LED modules are used together in a line
- Push terminals for quick and simple wiring of LED module to LED module
- Simple installation (push-fix bridge or screws)
- Long life-time: 50,000 hours
- 5-year guarantee



Standards, page 5

Colour temperatures and tolerances, page 9





Module LLE G3 16x140mm 650lm ADV,

LLE G3 16x280mm 1250lm ADV

Modules LLE

Technical data

| | |
|--|-----------------------|
| Beam characteristic | 120° |
| Ambient temperature range | -30 ... +45 °C |
| tp rated | 65 °C |
| tc | 85 °C |
| Max. DC forward current | 400 mA |
| Max. permissible LF current ripple | 440 mA |
| Max. permissible peak current | 1,000 mA / max. 10 µs |
| Max. permissible output voltage of LED Driver® | 300 V |
| Insulation test voltage | 1.6 kV |
| ESD classification | severity level 4 |
| Risk group (EN 62471:2008) | 1 |
| Type of protection | IP00 |

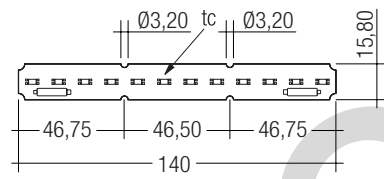
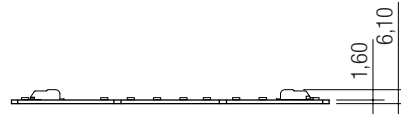

LLE G3 16x140mm 650lm ADV

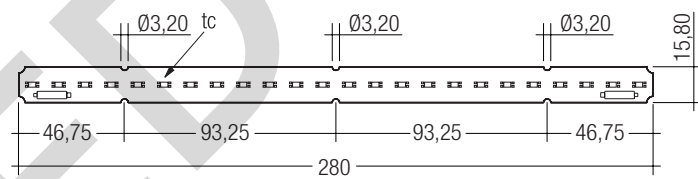
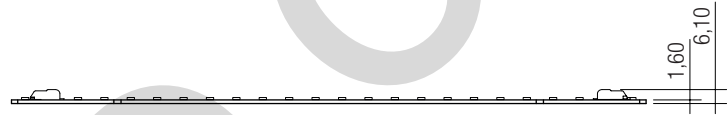

LLE G3 16x280mm 1250lm ADV

Ordering data

| Type | Article number | Colour temperature | Packaging carton | Weight per pc. |
|--------------------------------|----------------|--------------------|------------------|----------------|
| LLE G3 16x140mm 650lm 830 ADV | 89602056 | 3,000 K | 60 pc(s). | 0.008 kg |
| LLE G3 16x140mm 650lm 840 ADV | 89602057 | 4,000 K | 60 pc(s). | 0.008 kg |
| LLE G3 16x280mm 1250lm 830 ADV | 89602060 | 3,000 K | 30 pc(s). | 0.016 kg |
| LLE G3 16x280mm 1250lm 840 ADV | 89602061 | 4,000 K | 30 pc(s). | 0.016 kg |

Specific technical data

| Type ^① | Photo-metric code | Typ. luminous flux at tp = 25 °C ^② | Typ. luminous flux at tp = 65 °C ^② | Typ. forward current | Min. forward voltage at tp = 65 °C | Max. forward voltage at tp = 25 °C | Typ. power consumption at tp = 65 °C ^③ | Efficacy of the module at tp = 25 °C | Efficacy of the module at tp = 65 °C | Efficacy of the system at tp = 65 °C | Colour rendering index CRI |
|------------------------------------|-------------------|---|---|----------------------|------------------------------------|------------------------------------|---|--------------------------------------|--------------------------------------|--------------------------------------|----------------------------|
| Operating mode HE at 250 mA | | | | | | | | | | | |
| LLE G3 16x140mm 650lm 830 ADV | 830/349 | 600 lm | 555 lm | 250 mA | 16.3 V | 18.2 V | 4.3 W | 134 lm/W | 129 lm/W | 117 lm/W | > 80 |
| LLE G3 16x140mm 650lm 840 ADV | 840/349 | 650 lm | 610 lm | 250 mA | 16.3 V | 18.2 V | 4.3 W | 145 lm/W | 142 lm/W | 129 lm/W | > 80 |
| LLE G3 16x280mm 1250lm 830 ADV | 830/349 | 1,200 lm | 1,100 lm | 250 mA | 31.7 V | 36.7 V | 8.6 W | 134 lm/W | 128 lm/W | 116 lm/W | > 80 |
| LLE G3 16x280mm 1250lm 840 ADV | 840/349 | 1,300 lm | 1,220 lm | 250 mA | 31.7 V | 36.7 V | 8.6 W | 145 lm/W | 142 lm/W | 129 lm/W | > 80 |
| Operating mode HO at 300 mA | | | | | | | | | | | |
| LLE G3 16x140mm 650lm 830 ADV | 830/349 | 705 lm | 655 lm | 300 mA | 16.6 V | 18.6 V | 5.2 W | 129 lm/W | 126 lm/W | 115 lm/W | > 80 |
| LLE G3 16x140mm 650lm 840 ADV | 840/349 | 760 lm | 720 lm | 300 mA | 16.6 V | 18.6 V | 5.2 W | 139 lm/W | 138 lm/W | 126 lm/W | > 80 |
| LLE G3 16x280mm 1250lm 830 ADV | 830/349 | 1,410 lm | 1,290 lm | 300 mA | 32.5 V | 37.7 V | 10.5 W | 129 lm/W | 123 lm/W | 112 lm/W | > 80 |
| LLE G3 16x280mm 1250lm 840 ADV | 840/349 | 1,530 lm | 1,420 lm | 300 mA | 32.5 V | 37.7 V | 10.5 W | 140 lm/W | 135 lm/W | 123 lm/W | > 80 |
| Operating mode HO at 350 mA | | | | | | | | | | | |
| LLE G3 16x140mm 650lm 830 ADV | 830/349 | 810 lm | 750 lm | 350 mA | 16.8 V | 18.9 V | 6.2 W | 125 lm/W | 121 lm/W | 110 lm/W | > 80 |
| LLE G3 16x140mm 650lm 840 ADV | 840/349 | 875 lm | 820 lm | 350 mA | 16.8 V | 18.9 V | 6.2 W | 135 lm/W | 132 lm/W | 120 lm/W | > 80 |
| LLE G3 16x280mm 1250lm 830 ADV | 830/349 | 1,620 lm | 1,485 lm | 350 mA | 33.2 V | 38.5 V | 12.4 W | 125 lm/W | 120 lm/W | 109 lm/W | > 80 |
| LLE G3 16x280mm 1250lm 840 ADV | 840/349 | 1,745 lm | 1,620 lm | 350 mA | 33.2 V | 38.5 V | 12.4 W | 135 lm/W | 130 lm/W | 118 lm/W | > 80 |

^① Tolerance range for optical and electrical data: ±10 %.

^② If mounted with M3 screws and plastic washers.

^③ Integral measurement over the complete module.

^④ HE ... high efficiency, HO ... high output.

ACCES-
SORIES

BRIDGE LLE16

Product description

- Clip for fixation for LLE16
- Fast snap on mounting (for sheet thickness 0.5 – 1.0 mm)
- For drilling hole 3 mm
- Clip made of polycarbonate

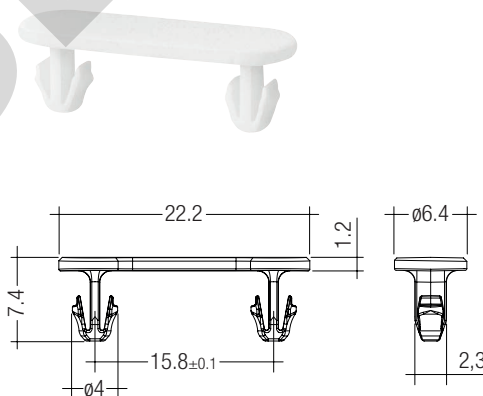

Ordering data

| Type | Article number | Colour | Packaging bag ^④ | Weight per pc. |
|---------------------------|----------------|--------|----------------------------|----------------|
| ACL BRIDGE LLE16 PUSH-FIX | 28001035 | White | 200 Stk. | 0.001 kg |

^④ Minimum sales quantity 200 pcs.

Product description

- LINEAR COVER for LLE 16
- Protection against direct touch for non-SELV applications
- Fast snap on mounting on to LLE 16 with clips or plastic washers
- High transmission: transparent 94 %, semi-transparent 87 %, diffuse 76 %
- Linear lense made of PMMA
- Tolerances LINEAR COVER: + 20 mm for 1,600 mm length (ends raw)

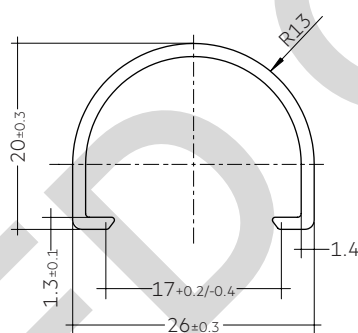
**Ordering data**

| Type | Article number | Colour | Length | Packaging carton | Weight per pc. |
|--|----------------|------------------|----------|------------------|----------------|
| ACL LINEAR COVER 16x1600mm TRANSPARENT | 28000949 | Transparent | 1,600 mm | 24 pc(s). | 0.147 kg |
| ACL LINEAR COVER 16x1600mm FROSTED | 28000950 | Semi-transparent | 1,600 mm | 24 pc(s). | 0.147 kg |
| ACL LINEAR COVER 16x1600mm DIFFUSE | 28000951 | Diffuse | 1,600 mm | 24 pc(s). | 0.147 kg |

1. Standards

IEC 62031
IEC 62471
IEC 62717
IEC 61000-4-2

1.1 Photometric code

Key for photometric code, e. g. 830 / 349

| 1 st digit | 2 nd + 3 rd digit | 4 th digit | 5 th digit | 6 th digit | | |
|-----------------------|---|-----------------------|---|--|--------|---------------|
| Code | Colour temperature in Kelvin x 100 | McAdam initial | McAdam after 25% of the life-time (max.6000h) | Luminous flux after 25% of the life-time (max.6000h) | | |
| 7 | | | | 70 – 79 | Code | Luminous flux |
| 8 | | | | 80 – 89 | 7 | ≥ 70 % |
| 9 | | | | ≥90 | 8 | ≥ 80 % |
| | | | | 9 | ≥ 90 % | |

1.2 Energy classification

| Type | Forward current | Energy classification |
|--------------------------------|-----------------|-----------------------|
| LLE G3 16x140mm 650lm 830 ADV | 250 mA | A++ |
| | 300 mA | A++ |
| | 350 mA | A+ |
| LLE G3 16x140mm 650lm 840 ADV | 250 mA | A++ |
| | 300 mA | A++ |
| | 350 mA | A++ |
| LLE G3 16x280mm 1250lm 830 ADV | 250 mA | A+ |
| | 300 mA | A+ |
| | 350 mA | A+ |
| LLE G3 16x280mm 1250lm 830 ADV | 250 mA | A++ |
| | 300 mA | A++ |
| | 350 mA | A+ |

2. Thermal details

2.1 tc point, ambient temperature and life-time

The temperature at tp reference point is crucial for the light output and life-time of a LED product.

For LLE a tp temperature of 65 °C has to be complied in order to achieve an optimum between heat sink requirements, light output and life-time.

Compliance with the maximum permissible reference temperature at the tc point must be checked under operating conditions in a thermally stable state. The maximum value must be determined under worst-case conditions for the relevant application.

The tc and tp temperature of LED modules from Tridonic are measured at the same reference point.

2.2 Storage and humidity

| | |
|---------------------|---------------|
| Storage temperature | -30... +80 °C |
|---------------------|---------------|

Operation only in non condensing environment.

Humidity during processing of the module should be between 0 to 70 %.

2.3 Thermal design and heat sink

The rated life of LED products depends to a large extent on the temperature. If the permissible temperature limits are exceeded, the life of the LLE will be greatly reduced or the LLE may be destroyed.

2.4 Heat sink values

LLE-G3-16-140

| ta | tp | Forward current | R _{th, hs-a} | Cooling area |
|-------|-------|-----------------|-----------------------|---------------------|
| 25 °C | 65 °C | 250 mA | 15.7 K/W | 43 cm ² |
| 25 °C | 65 °C | 300 mA | 12.5 K/W | 53 cm ² |
| 25 °C | 65 °C | 350 mA | 10.3 K/W | 64 cm ² |
| 35 °C | 65 °C | 250 mA | 12.0 K/W | 55 cm ² |
| 35 °C | 65 °C | 300 mA | 9.5 K/W | 70 cm ² |
| 35 °C | 65 °C | 350 mA | 7.7 K/W | 87 cm ² |
| 45 °C | 65 °C | 250 mA | 8.1 K/W | 81 cm ² |
| 45 °C | 65 °C | 300 mA | 6.3 K/W | 104 cm ² |
| 45 °C | 65 °C | 350 mA | 5.1 K/W | 130 cm ² |

LLE-G3-16-280

| ta | tp | Forward current | R _{th, hs-a} | Cooling area |
|-------|-------|-----------------|-----------------------|---------------------|
| 25 °C | 65 °C | 250 mA | 7.8 K/W | 85 cm ² |
| 25 °C | 65 °C | 300 mA | 6.2 K/W | 106 cm ² |
| 25 °C | 65 °C | 350 mA | 5.1 K/W | 130 cm ² |
| 35 °C | 65 °C | 250 mA | 6.0 K/W | 111 cm ² |
| 35 °C | 65 °C | 300 mA | 4.7 K/W | 140 cm ² |
| 35 °C | 65 °C | 350 mA | 3.8 K/W | 171 cm ² |
| 45 °C | 65 °C | 250 mA | 4.0 K/W | 163 cm ² |
| 45 °C | 65 °C | 300 mA | 3.1 K/W | 209 cm ² |
| 45 °C | 65 °C | 350 mA | 2.5 K/W | 259 cm ² |

Notes

The actual cooling surface can differ because of the material, the structural shape, outside influences and the installation situation. Depending on the heat sink a heat conducting paste or heat conducting film might be necessary to keep the specified tp temperature.

3. Installation / wiring

3.1 Electrical supply/choice of LED Driver

LLE modules from Tridonic are not protected against overvoltages, overcurrents, overloads or short-circuit currents. Safe and reliable operation can only be guaranteed in conjunction with a LED Driver which complies with the relevant standards. The use of LED Driver from Tridonic in combination with LLE modules guarantees the necessary protection for safe and reliable operation.

If a LED Driver other than Tridonic is used, it must provide the following protection:

- Short-circuit protection
- Overload protection
- Overtemperature protection



LLE modules must be supplied by a constant current LED Driver. Operation with a constant voltage LED Driver will lead to an irreversible damage of the module.

Wrong polarity can damage the LLE.

If LLE are wired in parallel and a wire breaks or a complete module fails then the current passing through the other module increases. This may reduce its life considerably. In addition there can be slight differences in light output caused by tolerances.

LLE modules can be operated either from SELV LED Drivers or from LED Drivers with LV output voltage.



LLE are basic isolated up to 300 V (if mounted with M4 screws in combination with plastic washers) against ground and can be mounted directly on earthed metal parts of the luminaire. If the max. output voltage of the LED Driver (also against earth) is above 300 V, an additional isolation between LED module and heat sink is required (for example by isolated thermal pads) or by a suitable luminaire construction.

At voltages > 60 V an additional protection against direct touch (test finger) to the light emitting side of the module has to be guaranteed. This is typically achieved by means of a non removable light distributor over the module.

3.2 Wiring



Wiring examples

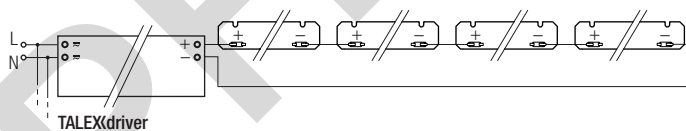

3.3 Wiring type and cross section

The wiring can be solid cable with a cross section of 0.2 to 0.75 mm². For the push-wire connection you have to strip the insulation (7–9 mm).

wire preparation:
0.2 – 0.75 mm²

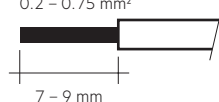

Inserting stranded wires / removing wires by lightly pressing on the push button.

3.4 Mounting instruction



None of the components of the LLE (substrate, LED, electronic components etc.) may be exposed to tensile or compressive stresses.

Max. torque for fixing: 0.5 Nm.

The LED modules are mounted onto a heat sink with min. 4 screws per module. In order not to damage the modules only rounded head screws and an additional plastic flat washer should be used.



Chemical substance may harm the LED module. Chemical reactions could lead to colour shift, reduced luminous flux or a total failure of the module caused by corrosion of electrical connections.

Materials which are used in LED applications (e.g. sealings, adhesives) must not produce dissolver gas. They must not be condensation curing based, acetate curing based or contain sulfur, chlorine or phthalate.

Avoid corrosive atmosphere during usage and storage.

3.5 EOS/ESD safety guidelines



The device / module contains components that are sensitive to electrostatic discharge and may only be installed in the factory and on site if appropriate EOS/ESD protection measures have been taken. No special measures need be taken for devices/modules with enclosed casings (contact with the pc board not possible), just normal installation practice. Please note the requirements set out in the document EOS / ESD guidelines (Guideline_EOS_ESD.pdf) at: <http://www.tridonic.com/esd-protection>

4. Life-time

4.1 Life-time, lumen maintenance and failure rate

The light output of an LED Module decreases over the life-time, this is characterized with the L value.

L70 means that the LED module will give 70 % of its initial luminous flux. This value is always related to the number of operation hours and therefore defines the life-time of an LED module.

As the L value is a statistical value and the lumen maintenance may vary over the delivered LED modules.

The B value defines the amount of modules which are below the specific L value, e.g. L70B10 means 10 % of the LED modules are below 70 % of the initial luminous flux, respectively 90 % will be above 70 % of the initial value. In addition the percentage of failed modules (fatal failure) is characterized by the C value.

The F value is the combination of the B and C value. That means for F degradation and complete failures are considered, e.g. L70F10 means 10 % of the LED modules may fail or be below 70 % of the initial luminous flux.

Life-time declarations are informative and represent no warranty claim.

4.2 Lumen maintenance for LLE G3 16

Life-time declarations are informative and represent no warranty claim.

| Forward current | tp temperature | L90 / F10 L90 / F50 L80 / F10 L80 / F50 L70 / F10 L70 / F50 | | | | | | |
|-----------------|----------------|---|-----------|-----------|-----------|-----------|-----------|--|
| | | L90 / F10 | L90 / F50 | L80 / F10 | L80 / F50 | L70 / F10 | L70 / F50 | |
| 250 mA | 65 °C | 23,000 h | 35,000 h | 49,000 h | >60,000 h | >60,000 h | >60,000 h | |
| 300 mA | 65 °C | 20,000 h | 30,000 h | 43,000 h | >60,000 h | >60,000 h | >60,000 h | |
| 350 mA | 65 °C | 17,000 h | 26,000 h | 36,000 h | 55,000 h | 58,000 h | >60,000 h | |

5. Electrical values

5.1 Typ. forward voltage vs. forward current

LLE G3 16x140mm 650lm

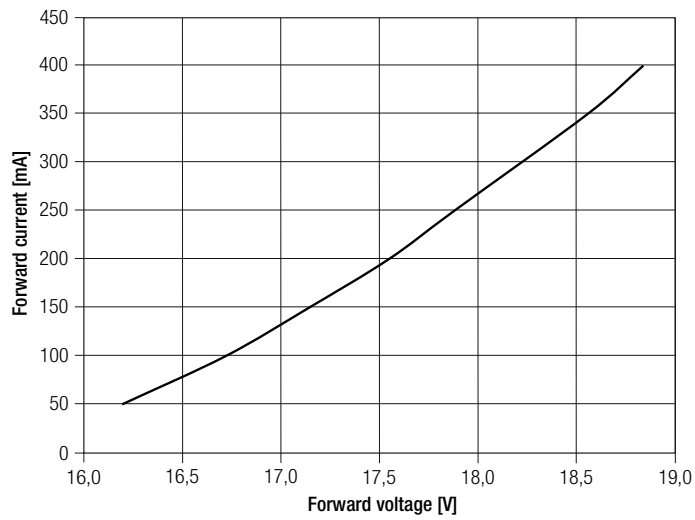

LLE G3 16x280mm 1250lm

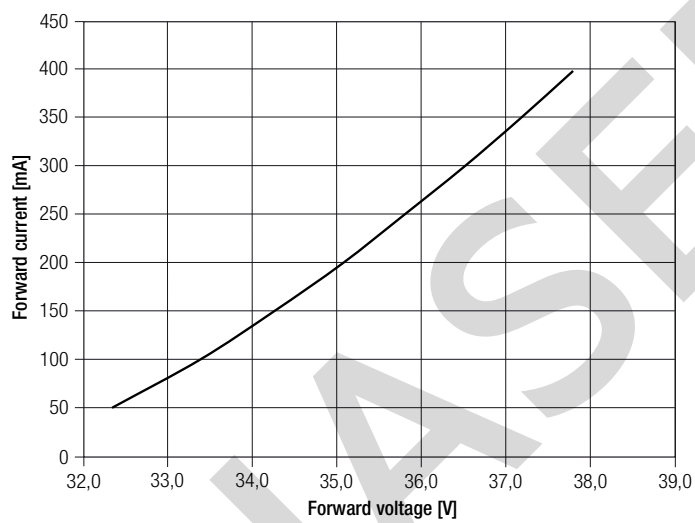

5.2 Forward voltage vs. tp temperature

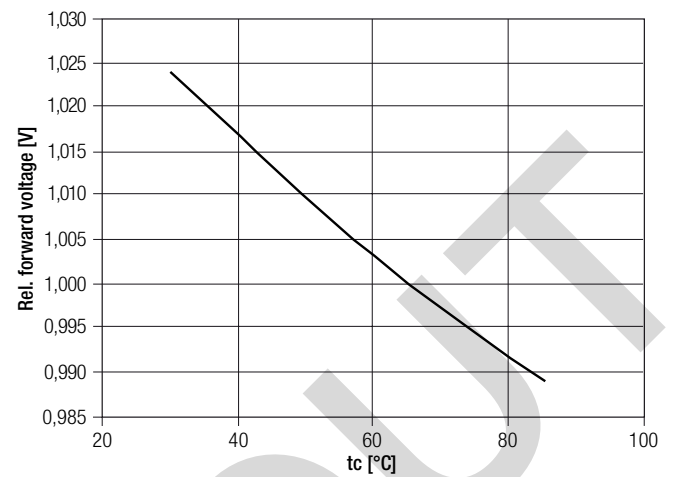

The diagrams are based on statistic values.
The real values can be different.

6. Photometric characteristics

6.1 Coordinates and tolerances according to CIE 1931

The specified colour coordinates are integral measured by a current impulse of 350 mA and a duration of 100 ms.

The ambient temperature of the measurement is $t_a = 25^\circ\text{C}$.

The measurement tolerance of the colour coordinates are ± 0.01 .

3,000 K

| | x0 | y0 |
|--------|--------|--------|
| Centre | 0.4284 | 0.4003 |

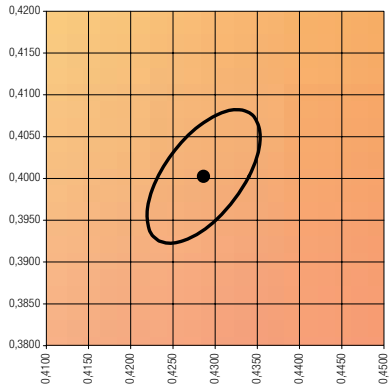

— MacAdam Ellipse: 3SDCM

4,000 K

| | x0 | y0 |
|--------|--------|--------|
| Centre | 0.3771 | 0.3737 |

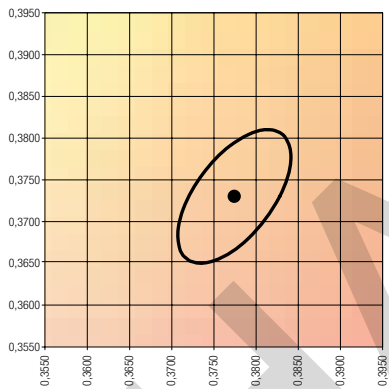

— MacAdam Ellipse: 3SDCM

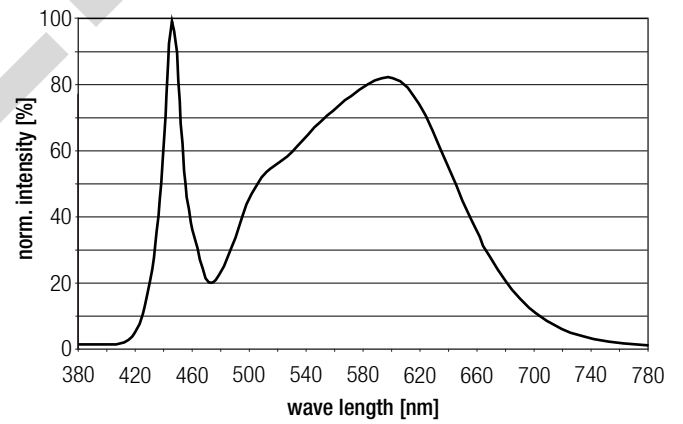
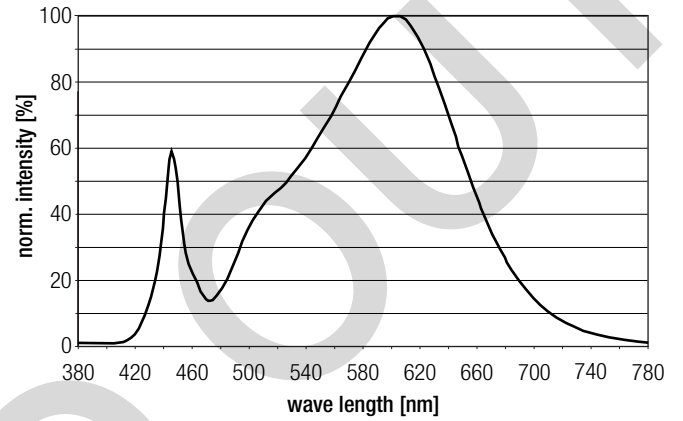

6.2 Light distribution

The optical design of the LLE product line ensures optimum homogeneity for the light distribution.

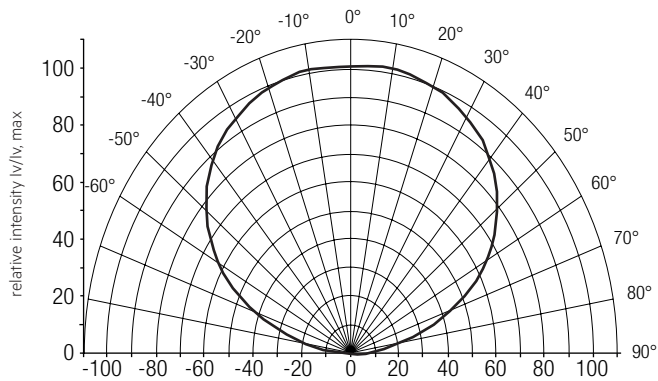

The colour temperature is measured integral over the complete module. The single LED light points can have deviations in the colour coordinates within MacAdam 7.

To ensure an ideal mixture of colours and a homogenous light distribution a suitable optic (e. g. PMMA diffuser) and a sufficient spacing between module and optic (typ. 4 cm) should be used.

For further information see Design-in Guide, 3D data and photometric data on www.tridonic.com or on request.

6.3 Relative luminous flux vs. tc temperature

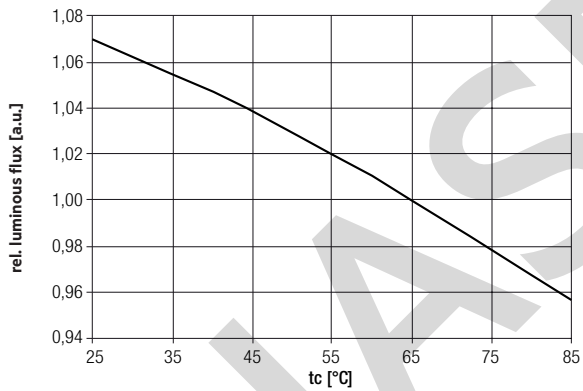

6.4 Relative luminous flux vs. operating current

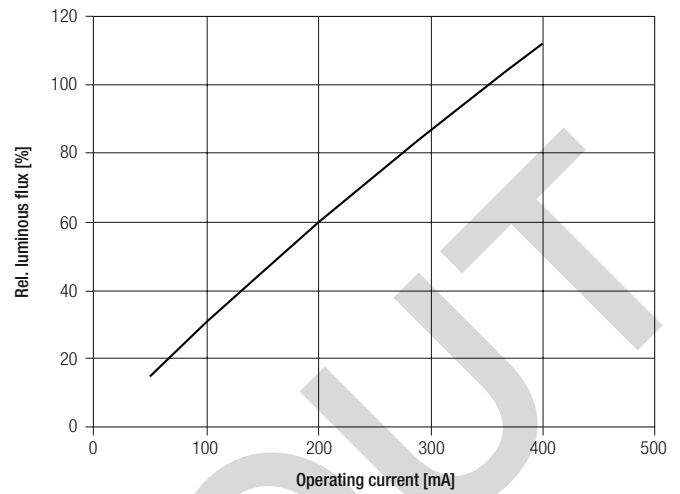

The diagrams are based on statistic values.
The real values can be different.