



### Driver LC 53W 250-350mA flexC Ip ADV

ADVANCED series

#### Product description

- Built-in constant current LED Driver
- Adjustable output current between 250 and 350 mA
- Max. output power 53 W
- Up to 92 % efficiency
- Nominal life-time up to 50,000 h
- For luminaires of protection class I and protection class II
- Temperature protection as per EN 61347-2-13 C5e
- 5-year guarantee

#### Housing properties

- Low-profile metal casing with white cover
- Type of protection IP20

#### Interfaces

- Terminal blocks: 45° push terminals

#### Functions

- Overload protection
- Short-circuit protection
- No-load protection
- Burst protection voltage 1 kV
- Surge protection voltage 1 kV (L to N)
- Surge protection voltage 2 kV (L/N to earth)

#### Typical applications

- For linear/area lighting in office applications



**Standards**, page 4

**Wiring diagrams and installation examples**, page 4

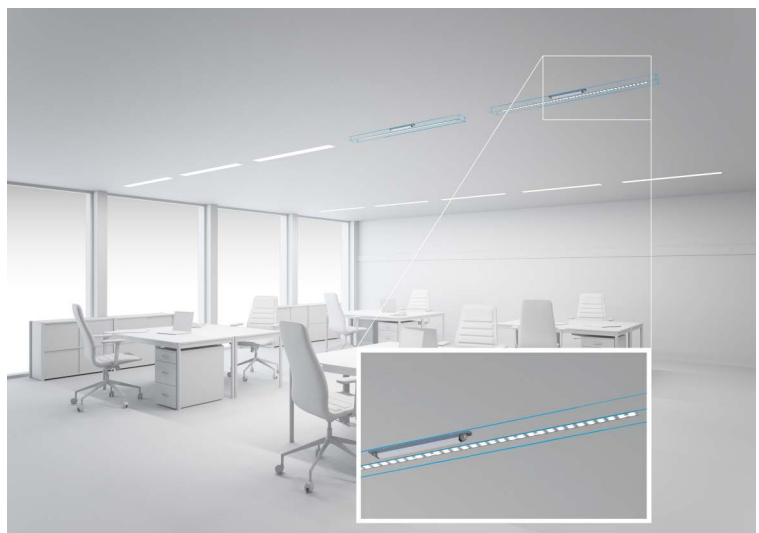
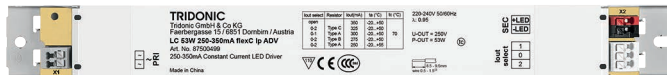

IP20                                                  

### Driver LC 53W 250-350mA flexC Ip ADV

ADVANCED series

#### Technical data

Rated supply voltage	220 – 240 V
AC voltage range	198 – 264 V
Max. input current (at 230 V, 50 Hz, full load)	0.27 A
Leakage current (at 230 V, 50 Hz, full load)	< 450 µA
Mains frequency	50 / 60 Hz
Overvoltage protection	320 V AC, 48 h
Max. input power	57 W
Typ. power consumption (at 230 V, 50 Hz, full load)	56.5 W
Min. output power	17.8 W
Max. output power	53 W
Typ. efficiency (at 230 V / 50 Hz / full load) <sup>①</sup>	92 %
λ (at 230 V, 50 Hz, full load) <sup>②</sup>	0.95
Output current tolerance <sup>③</sup>	± 7.5 %
Max. output current peak <sup>④</sup>	≤ output current + 10 %
Max. output voltage	250 V
THD (at 230 V, 50 Hz, full load)	< 20 %
Output LF current ripple (< 120 Hz)	± 5 %
Time to light (at 230 V, 50 Hz, full load)	≤ 0.5 s
Turn off time (at 230 V, 50 Hz, full load)	≤ 0.5 s
Hold on time at power failure (output)	0 s
Ambient temperature ta (at life-time 50,000 h)	40 °C
Storage temperature ts	-40 ... +80 °C
Dimensions L x W x H	280 x 30 x 21 mm
Hole spacing D	268 mm

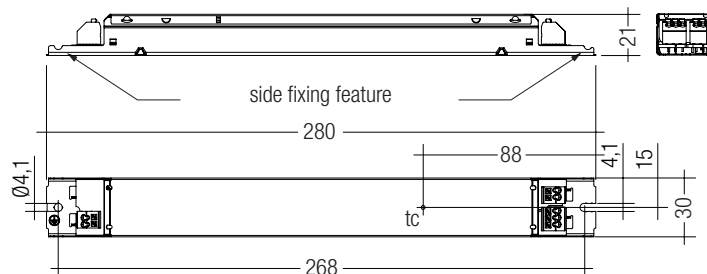

#### Ordering data

Type	Article number	Packaging, carton	Packaging, low volume	Packaging, high volume	Weight per pc.
LC 53W 250-350mA flexC Ip ADV	87500499	50 pc(s).	900 pc(s).	2,700 pc(s).	0.169 kg

#### Specific technical data

Type	Output current <sup>②</sup>	Min. forward voltage	Max. forward voltage	Max. output power	Typ. power consumption (at 230 V, 50 Hz, full load)	Typ. current consumption (at 230 V, 50 Hz, full load)	Max. casing temperature tc	Ambient temperature ta max.	I-out select	Resistor <sup>④</sup>
LC 53W 250-350mA flexC Ip ADV	250 mA	71 V	150 V	37.5 W	41.0 W	185 mA	70 °C	-20 ... +55 °C	0-2	ADV Type A
	275 mA	71 V	150 V	41.3 W	44.5 W	200 mA	70 °C	-20 ... +50 °C	0-2	ADV Type B
	300 mA	71 V	150 V	45.0 W	48.7 W	218 mA	70 °C	-20 ... +50 °C	0-1	ADV Type A
	325 mA	71 V	150 V	48.8 W	52.5 W	235 mA	70 °C	-20 ... +50 °C	0-2	ADV Type C
	350 mA	71 V	150 V	52.5 W	56.5 W	252 mA	70 °C	-20 ... +50 °C	open	-

<sup>①</sup> Test result at 350 mA.

<sup>②</sup> Output current is mean value.

<sup>③</sup> Test result at 25 °C.

<sup>④</sup> Type A is a short circuit plug (0 Ω).

## ADV Plug for output current select

**Product description**

- Ready-for-use resistor to set output current value
- Compatible with LED Driver serie LC flexC ADV;  
not compatible with I-select (generation 1) and  
I-select 2 (generation 2)
- Resistor is base isolated
- Resistor power 0.25 W
- Current tolerance  $\pm 2\%$  additional to output current tolerance
- Hot plug of the resistor is not permitted
- For detailed current setting see table "Specific technical data" of  
the respective LED Driver and chapter 3.8 Current setting

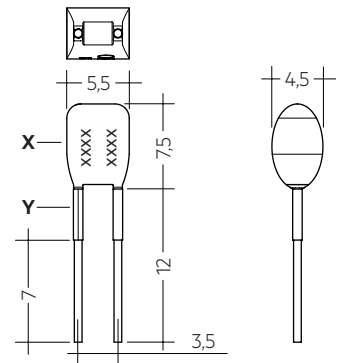
**Ordering data**

Type	Article number	Colour of X area	Colour of Y area	Marking	Resistor value	Packaging bag	Weight per pc.
ADV Plug Type A YL	28001771	Yellow	Yellow	A	0.0 $\Omega$	10 pc(s).	0.001 kg
ADV Plug Type B YL	28001772	Yellow	Black	B	3.16 k $\Omega$	10 pc(s).	0.001 kg
ADV Plug Type C YL	28001773	Yellow	Purple	C	28.7 k $\Omega$	10 pc(s).	0.001 kg

## 1. Standards

EN 55015  
EN 61000-3-2  
EN 61000-3-3  
EN 61347-1  
EN 61347-2-13  
EN 61547

## 2. Thermal details and life-time

### 2.1 Expected life-time

Expected life-time				
Type	ta	40 °C	50 °C	60 °C
LC 53W 250-350mA flexC Ip ADV	tc	60 °C	70 °C	x
	Life-time	50,000h	30,000h	x

The LED Driver is designed for a life-time stated above under reference conditions and with a failure probability of less than 10 %.

## 3. Installation / wiring

### 3.1 Circuit diagram

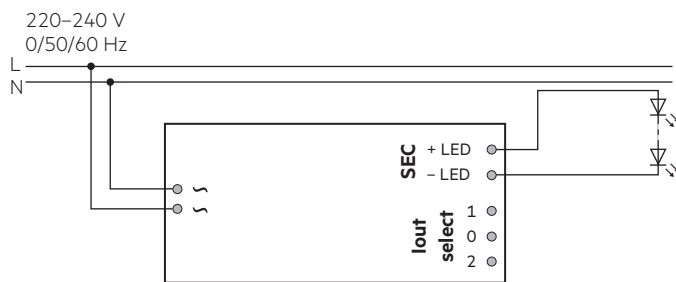

### 3.2 Wiring type and cross section

The wiring can be stranded wires with ferrules or rigid wires with a cross section of 0.5 – 1.5 mm<sup>2</sup>. Strip 8.5 – 9.5 mm of insulation from the cables to ensure perfect operation of the push-wire terminals.

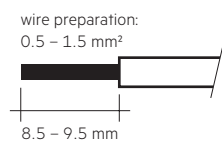

### 3.3 Release of the wiring

Press down the “push button” and remove the cable from front.

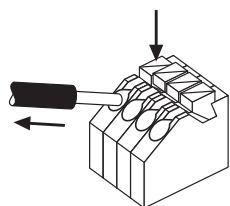

### 3.4 Installation instructions

The LED module and all contact points within the wiring must be sufficiently insulated against 3 kV surge voltage. Air and creepage distance must be maintained.

### 3.5 Wiring guidelines

- All connections must be kept as short as possible to ensure good EMI behaviour.
- Mains leads should be kept apart from LED Driver and other leads (ideally 5 – 10 cm distance)
- Max. length of output wires is 2 m.
- Incorrect wiring can damage LED modules.
- The wiring must be protected against short circuits to earth (sharp edged metal parts, metal cable clips, louver, etc.).
- The current selection has to be installed in the accordance to the requirement of low voltage installation.

### 3.6 Replace LED module

1. Mains off
2. Remove LED module
3. Wait for 20 seconds
4. Connect LED module again

Hot plug-in or output switching of LEDs is not permitted and may cause a very high current to the LEDs.

### 3.7 Earth connection

The earth connection is conducted as protection earth (PE). The LED Driver can be earthed via metal housing. If the LED Driver will be earthed, protection earth (PE) has to be used. There is no earth connection required for the functionality of the LED Driver. Earth connection is recommended to improve following behaviour.

- Electromagnetic interferences (EMI)
- Transmission of mains transients to the LED output

In general it is recommended to earth the LED Driver if the LED module is mounted on earthed luminaire parts respectively heat sinks and thereby representing a high capacity against earth.

For Class I application, protection earth need to connected with the metal housing (bottom part).

For Class II application, protection earth is no need to be connected, below 2 scenarios should be considered:

- If the LED Driver housing is screw on a metal part inside the luminaires, both LED Driver and LED module must be isolated.
- If the LED Driver housing is screw on a plastic part inside the luminaires, the LED module need to be isolated.

3.8 Current setting

**250 mA:** Terminal 0 and 2 connected with 0 Ω wire (max. 6 cm length) or resistor ADV Plug Type A BR (article number: 28001771)

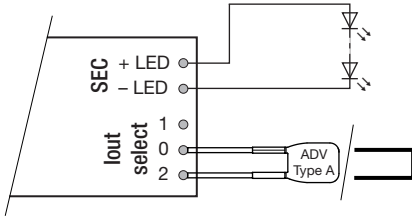

**275 mA:** Terminal 0 and 2 connected with resistor ADV Plug Type B BR (article number: 28001772)

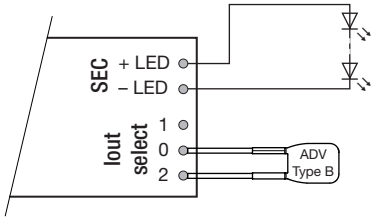

**300 mA:** Terminal 0 and 1 connected with 0 Ω wire (max. 6 cm length) or resistor ADV Plug Type A BR (article number: 28001771)

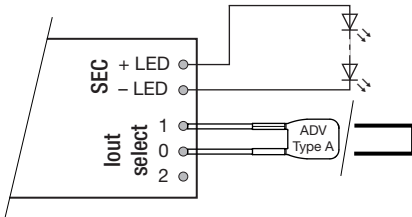

**325 mA:** Terminal 0 and 2 connected with resistor ADV Plug Type C BR (article number: 28001773)

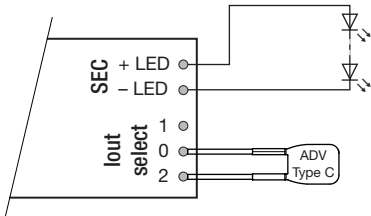

**350 mA:** All terminals open

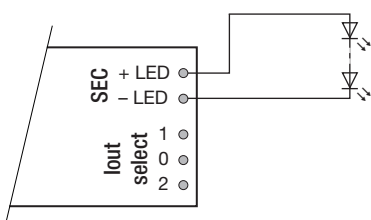

3.9 Mounting of device

Max. torque for fixing: 0.5 Nm/M4

4. Electrical values

Test at 230 V 50 Hz.

4.1 Efficiency vs load

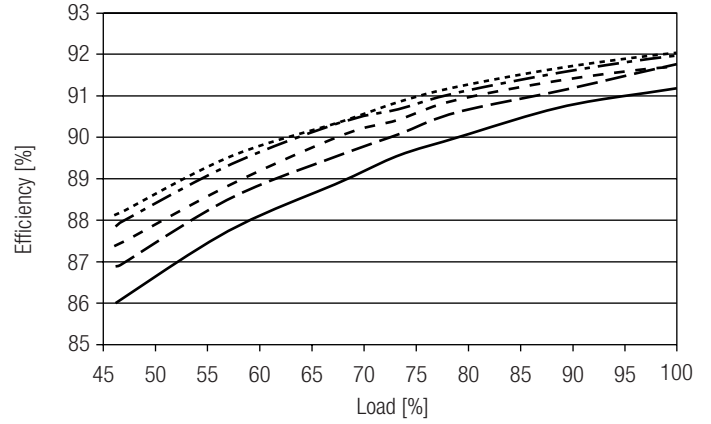

4.2 Power factor vs load

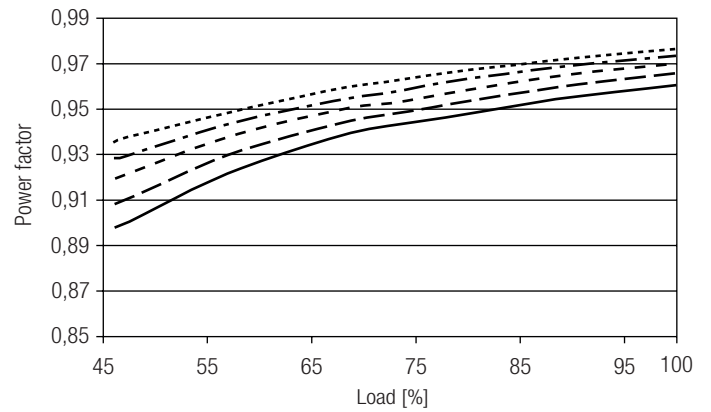

4.3 Input power vs load

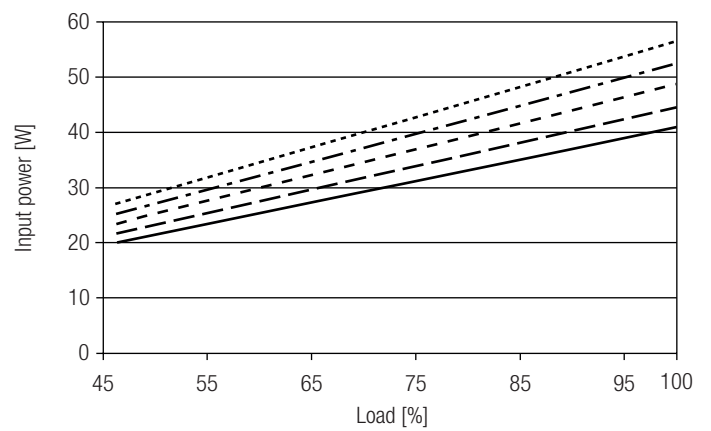

#### 4.4 Input current vs load

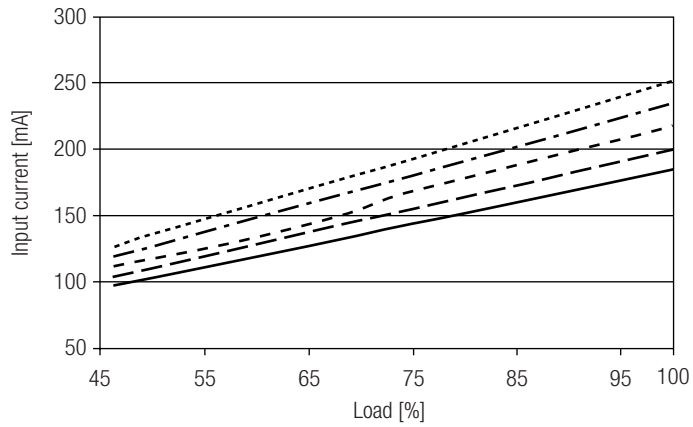

#### 4.5 THD vs load

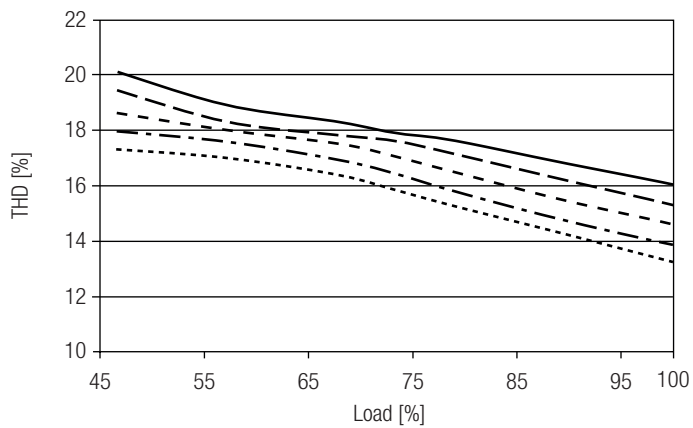

- 250 mA
- - - - 275 mA
- - - - 300 mA
- · - · 325 mA
- · · · 350 mA

#### 4.6 Maximum loading of automatic circuit breakers

Automatic circuit breaker type	C10	C13	C16	C20	B10	B13	B16	B20	Inrush current
Installation Ø	1.5 mm <sup>2</sup>	1.5 mm <sup>2</sup>	1.5 mm <sup>2</sup>	2.5 mm <sup>2</sup>	1.5 mm <sup>2</sup>	1.5 mm <sup>2</sup>	1.5 mm <sup>2</sup>	2.5 mm <sup>2</sup>	I <sub>max</sub> Time
<b>LC 53W 250-350mA flexC Ip ADV</b>	23	31	40	50	14	19	24	30	25 A    280 µs

#### 4.7 Harmonic distortion in the mains supply (at 230 V / 50 Hz and full load) in %

	THD	3.	5.	7.	9.	11.
<b>LC 53W 250-350mA flexC Ip ADV</b>	< 18	< 15	< 5	< 3	< 2	< 1

## 5. Functions

### 5.1 Short-circuit behaviour

In case of a short circuit on the output side (LED) the LED Driver switches into hic-cup mode. After elimination of the short-circuit fault the LED Driver will recover automatically.

### 5.2 No-load operation

The LED Driver works in burst working mode to provide a constant output voltage regulation which allows the application to be able to work safely when LED string opens due to a failure.

### 5.3 Overload protection

If the output voltage range is exceeded the LED Driver will protect itself and LED may flicker. After elimination of the overload, the nominal operation is restored automatically.

## 6. Miscellaneous

### 6.1 Isolation and electric strength testing of luminaires

Electronic devices can be damaged by high voltage. This has to be considered during the routine testing of the luminaires in production.

According to IEC 60598-1 Annex Q (informative only!) or ENEC 303-Annex A, each luminaire should be submitted to an isolation test with 500 V<sub>DC</sub> for 1 second. This test voltage should be connected between the interconnected phase and neutral terminals and the earth terminal.  
The isolation resistance must be at least 2 MΩ.

As an alternative, IEC 60598-1 Annex Q describes a test of the electrical strength with 1500 V<sub>AC</sub> (or 1.414 x 1500 V<sub>DC</sub>). To avoid damage to the electronic devices this test must not be conducted.

### 6.2 Storage conditions

Humidity: 5% up to max. 85%,  
not condensed  
(max. 56 days/year at 85%)

Storage temperature: -40 °C up to max. +80 °C

The devices have to be within the specified temperature range (t<sub>a</sub>) before they can be operated.

### 6.3 Additional information

Additional technical information at [www.tridonic.com](http://www.tridonic.com) → Technical Data

Guarantee conditions at [www.tridonic.com](http://www.tridonic.com) → Services

Life-time declarations are informative and represent no warranty claim.  
No warranty if device was opened.