



Module LLE G4 24mm 1250lm ADV

Modules LLE ADVANCED

Product description

- Ideal for linear and panel lights
- SELV module – the single module has a forward voltage < 60 V
- Terminals – 2 variants:
 - 2 terminals for serial wiring
 - 4 terminals for parallel, serial or robot wiring
- Typ. luminous flux 650, 1,250 and 2,400 lm
- LED system solution with outstanding system efficacy up to 166 lm/W, consisting of linear LED modules and dimmable LED Driver LCA 50W 100–400mA Ip PRE
- Efficacy of the module up to 187 lm/W
- High colour rendering index CRI > 80
- Small colour tolerance MacAdam 3^o
- Small luminous flux tolerances
- Colour temperatures 2,700 K, 3,000 K, 3,500 K, 4,000 K, 5,000 K and 6,500 K
- Module dimension 24 x 140 mm, 24 x 280 mm and 24 x 560 mm (ZHAGA compliant)
- Perfectly uniform light, even if several LED modules are used together in a line
- Push terminals for quick and simple wiring of LED module to LED module
- Simple installation (e.g. screws)
- Long life-time: 50,000 hours
- 5-year guarantee



LLE G4 24x280mm 1250lm ADV



LLE G4 24x560mm 2400lm ADV



Standards, page 10

Colour temperatures and tolerances, page 15





Module LLE G4 24mm 1250lm ADV

Modules LLE ADVANCED

Technical data

Beam characteristic	120°
Ambient temperature range	-40 ... +65 °C
tp rated	65 °C
tc	85 °C
Irated	325 mA
I _{max}	500 mA
Max. DC forward current	600 mA
Max. permissible LF current ripple	660 mA
Max. permissible peak current	780 mA / max. 10 ms
Max. working voltage for insulation [®]	320 V
Insulation test voltage	1.64 kV
CTI of the printed circuit board	≥ 600
ESD classification	severity level 4
Risk group (IEC 62471:2008) [®]	RG1
Classification acc. to IEC 62031	Built-in
Type of protection	IP00

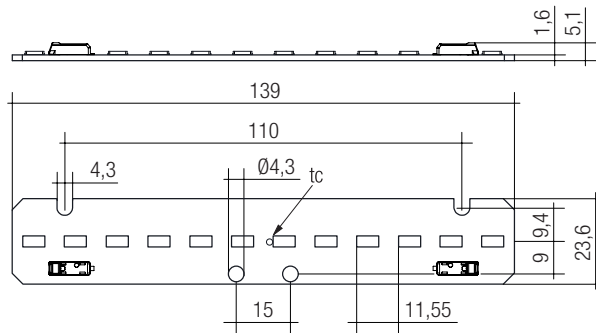

LLE G4 24x140mm 650lm ADV

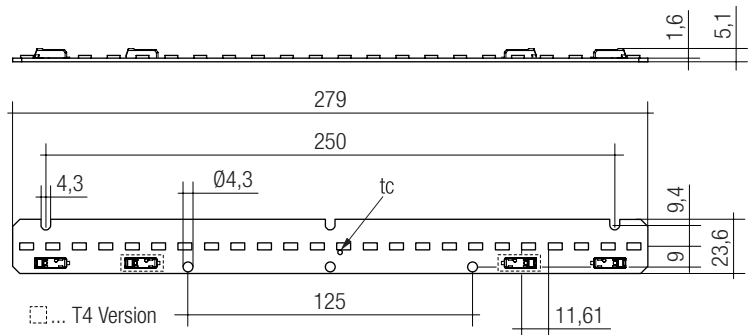

LLE G4 24x280mm 1250lm ADV

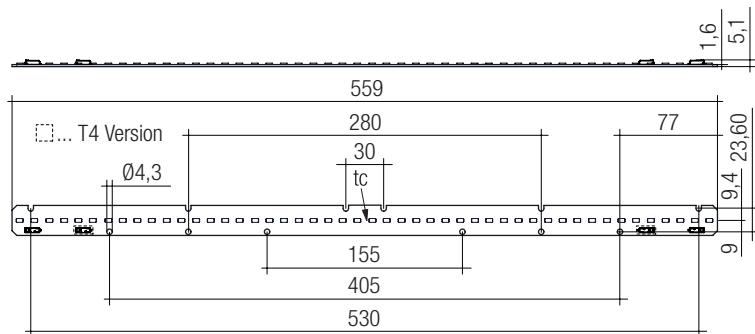

LLE G4 24x560mm 2400lm ADV

Module LLE G4 24mm 1250lm ADV

Modules LLE ADVANCED

Ordering data

Type	Article number	Colour temperature	Packaging carton	Weight per pc.
LLE 24mm ADVANCED 2 terminals (2T) for serial wiring				
LLE G4 24x140mm 650lm 830 2T ADV	28001481	3,000 K	480 pc(s).	0.012 kg
LLE G4 24x140mm 650lm 840 2T ADV	28001482	4,000 K	480 pc(s).	0.012 kg
LLE G4 24x140mm 650lm 850 2T ADV	28001483	5,000 K	480 pc(s).	0.012 kg
LLE G4 24x280mm 1250lm 830 2T ADV	28001486	3,000 K	300 pc(s).	0.023 kg
LLE G4 24x280mm 1250lm 840 2T ADV	28001487	4,000 K	300 pc(s).	0.023 kg
LLE G4 24x280mm 1250lm 850 2T ADV	28001488	5,000 K	300 pc(s).	0.023 kg
LLE G4 24x560mm 2400lm 830 2T ADV	28001491	3,000 K	240 pc(s).	0.046 kg
LLE G4 24x560mm 2400lm 840 2T ADV	28001492	4,000 K	240 pc(s).	0.046 kg
LLE G4 24x560mm 2400lm 850 2T ADV	28001493	5,000 K	240 pc(s).	0.046 kg
LLE 24mm ADVANCED 4 terminals (4T) for SELV				
LLE G4 24x280mm 1250lm 827 4T ADV	28001515	2,700 K	300 pc(s).	0.023 kg
LLE G4 24x280mm 1250lm 830 4T ADV	28001516	3,000 K	300 pc(s).	0.023 kg
LLE G4 24x280mm 1250lm 835 4T ADV	28001969	3,500 K	300 pc(s).	0.023 kg
LLE G4 24x280mm 1250lm 840 4T ADV	28001517	4,000 K	300 pc(s).	0.023 kg
LLE G4 24x280mm 1250lm 850 4T ADV	28001518	5,000 K	300 pc(s).	0.023 kg
LLE G4 24x280mm 1250lm 865 4T ADV	28001712	6,500 K	300 pc(s).	0.023 kg
LLE G4 24x560mm 2400lm 827 4T ADV	28001519	2,700 K	240 pc(s).	0.046 kg
LLE G4 24x560mm 2400lm 830 4T ADV	28001520	3,000 K	240 pc(s).	0.046 kg
LLE G4 24x560mm 2400lm 835 4T ADV	28001970	3,500 K	240 pc(s).	0.046 kg
LLE G4 24x560mm 2400lm 840 4T ADV	28001521	4,000 K	240 pc(s).	0.046 kg
LLE G4 24x560mm 2400lm 850 4T ADV	28001522	5,000 K	240 pc(s).	0.046 kg
LLE G4 24x560mm 2400lm 865 4T ADV	28001713	6,500 K	240 pc(s).	0.046 kg

Specific technical data

Type [®]	Photo-metric code	Typ. luminous flux at tp = 25 °C [®]	Typ. luminous flux at tp = 65 °C [®]	Typ. forward current	Min. forward voltage at tp = 65 °C	Max. forward voltage at tp = 25 °C	Typ. power consumption at tp = 65 °C [®]	Efficacy of the module at tp = 25 °C	Efficacy of the module at tp = 65 °C	Efficacy of the system at tp = 65 °C	Colour rendering index CRI
Operating mode HE at 225 mA											
LLE G4 24x140mm 650lm 830 ADV	830/359	440 lm	420 lm	225 mA	10.3 V	12.2 V	2.5 W	175 lm/W	169 lm/W	155 lm/W	> 80
LLE G4 24x140mm 650lm 840 ADV	840/359	460 lm	440 lm	225 mA	10.3 V	12.2 V	2.5 W	183 lm/W	176 lm/W	162 lm/W	> 80
LLE G4 24x140mm 650lm 850 ADV	850/359	470 lm	450 lm	225 mA	10.3 V	12.2 V	2.5 W	187 lm/W	180 lm/W	166 lm/W	> 80
LLE G4 24x280mm 1250lm 827 ADV	827/359	840 lm	800 lm	225 mA	20.6 V	23.9 V	5.0 W	165 lm/W	159 lm/W	146 lm/W	> 80
LLE G4 24x280mm 1250lm 830 ADV	830/359	890 lm	840 lm	225 mA	20.6 V	23.9 V	5.0 W	175 lm/W	169 lm/W	156 lm/W	> 80
LLE G4 24x280mm 1250lm 835 ADV	835/359	900 lm	850 lm	225 mA	20.6 V	23.9 V	5.0 W	177 lm/W	170 lm/W	156 lm/W	> 80
LLE G4 24x280mm 1250lm 840 ADV	840/359	930 lm	880 lm	225 mA	20.6 V	23.9 V	5.0 W	183 lm/W	176 lm/W	162 lm/W	> 80
LLE G4 24x280mm 1250lm 850 ADV	850/359	950 lm	900 lm	225 mA	20.6 V	23.9 V	5.0 W	187 lm/W	180 lm/W	166 lm/W	> 80
LLE G4 24x280mm 1250lm 865 ADV	865/359	930 lm	880 lm	225 mA	20.6 V	23.9 V	5.0 W	184 lm/W	176 lm/W	162 lm/W	> 80
LLE G4 24x560mm 2400lm 827 ADV	827/359	1,670 lm	1,600 lm	225 mA	41.3 V	47.8 V	10.0 W	165 lm/W	159 lm/W	146 lm/W	> 80
LLE G4 24x560mm 2400lm 830 ADV	830/359	1,770 lm	1,690 lm	225 mA	41.3 V	47.8 V	10.0 W	175 lm/W	169 lm/W	155 lm/W	> 80
LLE G4 24x560mm 2400lm 835 ADV	835/359	1,790 lm	1,700 lm	225 mA	41.3 V	47.8 V	10.0 W	177 lm/W	170 lm/W	156 lm/W	> 80
LLE G4 24x560mm 2400lm 840 ADV	840/359	1,850 lm	1,760 lm	225 mA	41.3 V	47.8 V	10.0 W	183 lm/W	176 lm/W	162 lm/W	> 80
LLE G4 24x560mm 2400lm 850 ADV	850/359	1,890 lm	1,790 lm	225 mA	41.3 V	47.8 V	10.0 W	187 lm/W	180 lm/W	166 lm/W	> 80
LLE G4 24x560mm 2400lm 865 ADV	865/359	1,860 lm	1,760 lm	225 mA	41.3 V	47.8 V	10.0 W	184 lm/W	176 lm/W	162 lm/W	> 80
Operating mode HE at 275 mA											
LLE G4 24x140mm 650lm 830 ADV	830/359	540 lm	510 lm	275 mA	10.5 V	12.3 V	3.1 W	171 lm/W	166 lm/W	153 lm/W	> 80
LLE G4 24x140mm 650lm 840 ADV	840/359	560 lm	530 lm	275 mA	10.5 V	12.3 V	3.1 W	180 lm/W	173 lm/W	159 lm/W	> 80
LLE G4 24x140mm 650lm 850 ADV	850/359	570 lm	540 lm	275 mA	10.5 V	12.3 V	3.1 W	183 lm/W	176 lm/W	162 lm/W	> 80
LLE G4 24x280mm 1250lm 827 ADV	827/359	1,010 lm	970 lm	275 mA	20.9 V	24.2 V	6.2 W	161 lm/W	156 lm/W	144 lm/W	> 80
LLE G4 24x280mm 1250lm 830 ADV	830/359	1,070 lm	1,020 lm	275 mA	20.9 V	24.2 V	6.2 W	171 lm/W	166 lm/W	153 lm/W	> 80
LLE G4 24x280mm 1250lm 835 ADV	835/359	1,080 lm	1,030 lm	275 mA	20.9 V	24.2 V	6.2 W	173 lm/W	167 lm/W	154 lm/W	> 80
LLE G4 24x280mm 1250lm 840 ADV	840/359	1,120 lm	1,070 lm	275 mA	20.9 V	24.2 V	6.2 W	180 lm/W	173 lm/W	159 lm/W	> 80
LLE G4 24x280mm 1250lm 850 ADV	850/359	1,150 lm	1,090 lm	275 mA	20.9 V	24.2 V	6.2 W	183 lm/W	176 lm/W	162 lm/W	> 80
LLE G4 24x280mm 1250lm 865 ADV	865/359	1,130 lm	990 lm	275 mA	20.9 V	24.2 V	6.2 W	180 lm/W	173 lm/W	159 lm/W	> 80
LLE G4 24x560mm 2400lm 827 ADV	827/359	2,030 lm	1,930 lm	275 mA	41.9 V	48.4 V	12.3 W	161 lm/W	156 lm/W	144 lm/W	> 80
LLE G4 24x560mm 2400lm 830 ADV	830/359	2,150 lm	2,040 lm	275 mA	41.9 V	48.4 V	12.3 W	171 lm/W	166 lm/W	153 lm/W	> 80
LLE G4 24x560mm 2400lm 835 ADV	835/359	2,170 lm	2,050 lm	275 mA	41.9 V	48.4 V	12.3 W	173 lm/W	167 lm/W	154 lm/W	> 80
LLE G4 24x560mm 2400lm 840 ADV	840/359	2,250 lm	2,130 lm	275 mA	41.9 V	48.4 V	12.3 W	180 lm/W	173 lm/W	159 lm/W	> 80
LLE G4 24x560mm 2400lm 850 ADV	850/359	2,290 lm	2,170 lm	275 mA	41.9 V	48.4 V	12.3 W	183 lm/W	176 lm/W	162 lm/W	> 80
LLE G4 24x560mm 2400lm 865 ADV	865/359	2,260 lm	2,130 lm	275 mA	41.9 V	48.4 V	12.3 W	180 lm/W	173 lm/W	159 lm/W	> 80
Operating mode NM at 300 mA											
LLE G4 24x140mm 650lm 830 ADV	830/359	580 lm	550 lm	300 mA	10.5 V	12.4 V	3.4 W	170 lm/W	164 lm/W	151 lm/W	> 80
LLE G4 24x140mm 650lm 840 ADV	840/359	610 lm	580 lm	300 mA	10.5 V	12.4 V	3.4 W	178 lm/W	171 lm/W	157 lm/W	> 80
LLE G4 24x140mm 650lm 850 ADV	850/359	620 lm	590 lm	300 mA	10.5 V	12.4 V	3.4 W	181 lm/W	174 lm/W	160 lm/W	> 80
LLE G4 24x280mm 1250lm 827 ADV	827/359	1,100 lm	1,050 lm	300 mA	21.1 V	24.4 V	6.8 W	160 lm/W	155 lm/W	143 lm/W	> 80
LLE G4 24x280mm 1250lm 830 ADV	830/359	1,160 lm	1,110 lm	300 mA	21.1 V	24.4 V	6.8 W	170 lm/W	164 lm/W	151 lm/W	> 80
LLE G4 24x280mm 1250lm 835 ADV	835/359	1,170 lm	1,110 lm	300 mA	21.1 V	24.4 V	6.8 W	171 lm/W	165 lm/W	152 lm/W	> 80
LLE G4 24x280mm 1250lm 840 ADV	840/359	1,220 lm	1,160 lm	300 mA	21.1 V	24.4 V	6.8 W	178 lm/W	171 lm/W	157 lm/W	> 80
LLE G4 24x280mm 1250lm 850 ADV	850/359	1,240 lm	1,180 lm	300 mA	21.1 V	24.4 V	6.8 W	181 lm/W	174 lm/W	160 lm/W	> 80
LLE G4 24x280mm 1250lm 865 ADV	865/359	1,230 lm	1,160 lm	300 mA	21.1 V	24.4 V	6.8 W	179 lm/W	171 lm/W	157 lm/W	> 80
LLE G4 24x560mm 2400lm 827 ADV	827/359	2,200 lm	2,100 lm	300 mA	42.2 V	48.7 V	13.5 W	160 lm/W	155 lm/W	143 lm/W	> 80
LLE G4 24x560mm 2400lm 830 ADV	830/359	2,330 lm	2,220 lm	300 mA	42.2 V	48.7 V	13.5 W	170 lm/W	164 lm/W	151 lm/W	> 80
LLE G4 24x560mm 2400lm 835 ADV	835/359	2,330 lm	2,230 lm	300 mA	42.2 V	48.7 V	13.5 W	171 lm/W	165 lm/W	152 lm/W	> 80
LLE G4 24x560mm 2400lm 840 ADV	840/359	2,440 lm	2,320 lm	300 mA	42.2 V	48.7 V	13.5 W	178 lm/W	171 lm/W	157 lm/W	> 80
LLE G4 24x560mm 2400lm 850 ADV	850/359	2,490 lm	2,360 lm	300 mA	42.2 V	48.7 V	13.5 W	181 lm/W	174 lm/W	160 lm/W	> 80
LLE G4 24x560mm 2400lm 865 ADV	865/359	2,450 lm	2,320 lm	300 mA	42.2 V	48.7 V	13.5 W	179 lm/W	171 lm/W	157 lm/W	> 80

[®] Integral measurement over the complete module.

[®] If mounted with M4 screws and plastic washers.

[®] Measured at operating mode HO.

[®] HE ... high efficiency, NM ... nominal mode, HO ... high output.

[®] Tolerance range for optical and electrical data: ±10 %.

Specific technical data

Type [Ⓢ]	Photo-metric code	Typ. luminous flux at tp = 25 °C [Ⓢ]	Typ. luminous flux at tp = 65 °C [Ⓢ]	Typ. forward current	Min. forward voltage at tp = 65 °C	Max. forward voltage at tp = 25 °C	Typ. power consumption at tp = 65 °C [Ⓢ]	Efficacy of the module at tp = 25 °C	Efficacy of the module at tp = 65 °C	Efficacy of the system at tp = 65 °C	Colour rendering index CRI
Operating mode NM at 325 mA											
LLE G4 24x140mm 650lm 830 ADV	830/359	630 lm	600 lm	325 mA	10.6 V	12.5 V	3.7 W	167 lm/W	162 lm/W	149 lm/W	> 80
LLE G4 24x140mm 650lm 840 ADV	840/359	660 lm	630 lm	325 mA	10.6 V	12.5 V	3.7 W	176 lm/W	170 lm/W	156 lm/W	> 80
LLE G4 24x140mm 650lm 850 ADV	850/359	670 lm	630 lm	325 mA	10.6 V	12.5 V	3.7 W	178 lm/W	172 lm/W	158 lm/W	> 80
LLE G4 24x280mm 1250lm 827 ADV	827/359	1,180 lm	1,130 lm	325 mA	21.2 V	24.5 V	7.4 W	158 lm/W	153 lm/W	141 lm/W	> 80
LLE G4 24x280mm 1250lm 830 ADV	830/359	1,250 lm	1,190 lm	325 mA	21.2 V	24.5 V	7.4 W	167 lm/W	162 lm/W	149 lm/W	> 80
LLE G4 24x280mm 1250lm 835 ADV	835/359	1,270 lm	1,200 lm	325 mA	21.2 V	24.5 V	7.4 W	170 lm/W	163 lm/W	150 lm/W	> 80
LLE G4 24x280mm 1250lm 840 ADV	840/359	1,320 lm	1,250 lm	325 mA	21.2 V	24.5 V	7.4 W	176 lm/W	170 lm/W	156 lm/W	> 80
LLE G4 24x280mm 1250lm 850 ADV	850/359	1,340 lm	1,260 lm	325 mA	21.2 V	24.5 V	7.4 W	178 lm/W	172 lm/W	158 lm/W	> 80
LLE G4 24x560mm 2400lm 827 ADV	827/359	2,360 lm	2,250 lm	325 mA	42.4 V	49.0 V	14.7 W	158 lm/W	153 lm/W	141 lm/W	> 80
LLE G4 24x560mm 2400lm 830 ADV	830/359	2,500 lm	2,380 lm	325 mA	42.4 V	49.0 V	14.7 W	167 lm/W	162 lm/W	149 lm/W	> 80
LLE G4 24x560mm 2400lm 835 ADV	835/359	2,530 lm	2,400 lm	325 mA	42.4 V	49.0 V	14.7 W	170 lm/W	163 lm/W	150 lm/W	> 80
LLE G4 24x560mm 2400lm 840 ADV	840/359	2,630 lm	2,500 lm	325 mA	42.4 V	49.0 V	14.7 W	176 lm/W	170 lm/W	156 lm/W	> 80
LLE G4 24x560mm 2400lm 850 ADV	850/359	2,670 lm	2,530 lm	325 mA	42.4 V	49.0 V	14.7 W	178 lm/W	172 lm/W	158 lm/W	> 80
LLE G4 24x560mm 2400lm 865 ADV	865/359	2,650 lm	2,500 lm	325 mA	42.4 V	49.0 V	14.7 W	177 lm/W	170 lm/W	156 lm/W	> 80
Operating mode NM at 350 mA											
LLE G4 24x140mm 650lm 830 ADV	830/359	670 lm	640 lm	350 mA	10.7 V	12.6 V	4.0 W	166 lm/W	160 lm/W	147 lm/W	> 80
LLE G4 24x140mm 650lm 840 ADV	840/359	700 lm	670 lm	350 mA	10.7 V	12.6 V	4.0 W	174 lm/W	167 lm/W	153 lm/W	> 80
LLE G4 24x140mm 650lm 850 ADV	850/359	720 lm	680 lm	350 mA	10.7 V	12.6 V	4.0 W	176 lm/W	170 lm/W	156 lm/W	> 80
LLE G4 24x280mm 1250lm 827 ADV	827/359	1,270 lm	1,210 lm	350 mA	21.4 V	24.6 V	8.0 W	157 lm/W	152 lm/W	140 lm/W	> 80
LLE G4 24x280mm 1250lm 830 ADV	830/359	1,340 lm	1,280 lm	350 mA	21.4 V	24.6 V	8.0 W	166 lm/W	160 lm/W	147 lm/W	> 80
LLE G4 24x280mm 1250lm 835 ADV	835/359	1,350 lm	1,290 lm	350 mA	21.4 V	24.6 V	8.0 W	165 lm/W	159 lm/W	146 lm/W	> 80
LLE G4 24x280mm 1250lm 840 ADV	840/359	1,410 lm	1,340 lm	350 mA	21.4 V	24.6 V	8.0 W	174 lm/W	167 lm/W	154 lm/W	> 80
LLE G4 24x280mm 1250lm 850 ADV	850/359	1,440 lm	1,360 lm	350 mA	21.4 V	24.6 V	8.0 W	176 lm/W	170 lm/W	156 lm/W	> 80
LLE G4 24x280mm 1250lm 865 ADV	865/359	1,420 lm	1,340 lm	350 mA	21.4 V	24.6 V	8.0 W	175 lm/W	167 lm/W	154 lm/W	> 80
LLE G4 24x560mm 2400lm 827 ADV	827/359	2,540 lm	2,420 lm	350 mA	42.7 V	49.3 V	16.0 W	157 lm/W	152 lm/W	140 lm/W	> 80
LLE G4 24x560mm 2400lm 830 ADV	830/359	2,690 lm	2,560 lm	350 mA	42.7 V	49.3 V	16.0 W	166 lm/W	160 lm/W	147 lm/W	> 80
LLE G4 24x560mm 2400lm 835 ADV	835/359	2,690 lm	2,570 lm	350 mA	42.7 V	49.3 V	16.0 W	165 lm/W	159 lm/W	146 lm/W	> 80
LLE G4 24x560mm 2400lm 840 ADV	840/359	2,810 lm	2,670 lm	350 mA	42.7 V	49.3 V	16.0 W	173 lm/W	167 lm/W	154 lm/W	> 80
LLE G4 24x560mm 2400lm 850 ADV	850/359	2,870 lm	2,720 lm	350 mA	42.7 V	49.3 V	16.0 W	176 lm/W	170 lm/W	156 lm/W	> 80
LLE G4 24x560mm 2400lm 865 ADV	865/359	2,830 lm	2,670 lm	350 mA	42.7 V	49.3 V	16.0 W	175 lm/W	167 lm/W	154 lm/W	> 80
Operating mode HO at 400 mA											
LLE G4 24x140mm 650lm 830 ADV	830/359	750 lm	710 lm	400 mA	10.8 V	12.7 V	4.6 W	160 lm/W	154 lm/W	142 lm/W	> 80
LLE G4 24x140mm 650lm 840 ADV	840/359	790 lm	750 lm	400 mA	10.8 V	12.7 V	4.6 W	168 lm/W	162 lm/W	149 lm/W	> 80
LLE G4 24x140mm 650lm 850 ADV	850/359	800 lm	760 lm	400 mA	10.8 V	12.7 V	4.6 W	171 lm/W	164 lm/W	151 lm/W	> 80
LLE G4 24x280mm 1250lm 827 ADV	827/359	1,420 lm	1,350 lm	400 mA	21.6 V	24.9 V	9.2 W	151 lm/W	146 lm/W	134 lm/W	> 80
LLE G4 24x280mm 1250lm 830 ADV	830/359	1,500 lm	1,430 lm	400 mA	21.6 V	24.9 V	9.2 W	160 lm/W	154 lm/W	142 lm/W	> 80
LLE G4 24x280mm 1250lm 835 ADV	835/359	1,520 lm	1,440 lm	400 mA	21.6 V	24.9 V	9.2 W	162 lm/W	157 lm/W	144 lm/W	> 80
LLE G4 24x280mm 1250lm 840 ADV	840/359	1,580 lm	1,500 lm	400 mA	21.6 V	24.9 V	9.2 W	168 lm/W	162 lm/W	149 lm/W	> 80
LLE G4 24x280mm 1250lm 850 ADV	850/359	1,600 lm	1,510 lm	400 mA	21.6 V	24.9 V	9.2 W	171 lm/W	164 lm/W	151 lm/W	> 80
LLE G4 24x280mm 1250lm 865 ADV	865/359	1,590 lm	1,500 lm	400 mA	21.6 V	24.9 V	9.2 W	170 lm/W	162 lm/W	149 lm/W	> 80
LLE G4 24x560mm 2400lm 827 ADV	827/359	2,830 lm	2,700 lm	400 mA	43.2 V	49.8 V	18.4 W	151 lm/W	146 lm/W	134 lm/W	> 80
LLE G4 24x560mm 2400lm 830 ADV	830/359	3,000 lm	2,850 lm	400 mA	43.2 V	49.8 V	18.4 W	160 lm/W	154 lm/W	142 lm/W	> 80
LLE G4 24x560mm 2400lm 835 ADV	835/359	3,030 lm	2,880 lm	400 mA	43.2 V	49.8 V	18.4 W	162 lm/W	157 lm/W	144 lm/W	> 80
LLE G4 24x560mm 2400lm 840 ADV	840/359	3,160 lm	2,990 lm	400 mA	43.2 V	49.8 V	18.4 W	168 lm/W	162 lm/W	149 lm/W	> 80
LLE G4 24x560mm 2400lm 850 ADV	850/359	3,200 lm	3,030 lm	400 mA	43.2 V	49.8 V	18.4 W	171 lm/W	164 lm/W	151 lm/W	> 80
LLE G4 24x560mm 2400lm 865 ADV	865/359	3,180 lm	3,000 lm	400 mA	43.2 V	49.8 V	18.4 W	170 lm/W	162 lm/W	149 lm/W	> 80

[Ⓢ] Integral measurement over the complete module.

[Ⓢ] If mounted with M4 screws and plastic washers.

[Ⓢ] Measured at operating mode HO.

[Ⓢ] HE ... high efficiency, NM ... nominal mode, HO ... high output.

[Ⓢ] Tolerance range for optical and electrical data: ±10 %.

Specific technical data

Type [Ⓐ]	Photo-metric code	Typ, luminous flux at tp = 25 °C [Ⓢ]	Typ, luminous flux at tp = 65 °C [Ⓢ]	Typ, forward current	Min, forward voltage at tp = 65 °C	Max, forward voltage at tp = 25 °C	Typ, power consumption at tp = 65 °C [Ⓢ]	Efficacy of the module at tp = 25 °C	Efficacy of the module at tp = 65 °C	Efficacy of the system at tp = 65 °C	Colour rendering index CRI
Operating mode HO at 450 mA											
LLE G4 24x140mm 650lm 830 ADV	830/359	840 lm	800 lm	450 mA	10.9 V	12.8 V	5.2 W	157 lm/W	152 lm/W	140 lm/W	> 80
LLE G4 24x140mm 650lm 840 ADV	840/359	870 lm	830 lm	450 mA	10.9 V	12.8 V	5.2 W	165 lm/W	158 lm/W	145 lm/W	> 80
LLE G4 24x140mm 650lm 850 ADV	850/359	890 lm	840 lm	450 mA	10.9 V	12.8 V	5.2 W	168 lm/W	161 lm/W	148 lm/W	> 80
LLE G4 24x280mm 1250lm 827 ADV	827/359	1,580 lm	1,510 lm	450 mA	21.9 V	25.2 V	10.5 W	148 lm/W	144 lm/W	132 lm/W	> 80
LLE G4 24x280mm 1250lm 830 ADV	830/359	1,670 lm	1,590 lm	450 mA	21.9 V	25.2 V	10.5 W	157 lm/W	152 lm/W	140 lm/W	> 80
LLE G4 24x280mm 1250lm 835 ADV	835/359	1,690 lm	1,620 lm	450 mA	21.9 V	25.2 V	10.5 W	159 lm/W	154 lm/W	142 lm/W	> 80
LLE G4 24x280mm 1250lm 840 ADV	840/359	1,750 lm	1,660 lm	450 mA	21.9 V	25.2 V	10.5 W	165 lm/W	158 lm/W	145 lm/W	> 80
LLE G4 24x280mm 1250lm 850 ADV	850/359	1,780 lm	1,690 lm	450 mA	21.9 V	25.2 V	10.5 W	168 lm/W	161 lm/W	148 lm/W	> 80
LLE G4 24x280mm 1250lm 865 ADV	865/359	1,760 lm	1,660 lm	450 mA	21.9 V	25.2 V	10.5 W	165 lm/W	158 lm/W	145 lm/W	> 80
LLE G4 24x560mm 2400lm 827 ADV	827/359	3,150 lm	3,010 lm	450 mA	43.8 V	50.3 V	21.0 W	148 lm/W	144 lm/W	132 lm/W	> 80
LLE G4 24x560mm 2400lm 830 ADV	830/359	3,340 lm	3,180 lm	450 mA	43.8 V	50.3 V	21.0 W	157 lm/W	152 lm/W	140 lm/W	> 80
LLE G4 24x560mm 2400lm 835 ADV	835/359	3,390 lm	3,230 lm	450 mA	43.8 V	50.3 V	21.0 W	159 lm/W	155 lm/W	142 lm/W	> 80
LLE G4 24x560mm 2400lm 840 ADV	840/359	3,500 lm	3,320 lm	450 mA	43.8 V	50.3 V	21.0 W	165 lm/W	158 lm/W	145 lm/W	> 80
LLE G4 24x560mm 2400lm 850 ADV	850/359	3,570 lm	3,380 lm	450 mA	43.8 V	50.3 V	21.0 W	168 lm/W	161 lm/W	175 lm/W	> 80
LLE G4 24x560mm 2400lm 865 ADV	865/359	3,520 lm	3,320 lm	450 mA	43.8 V	50.3 V	21.0 W	165 lm/W	158 lm/W	145 lm/W	> 80
Operating mode HO at 500 mA											
LLE G4 24x140mm 650lm 830 ADV	830/359	910 lm	870 lm	500 mA	11.1 V	12.9 V	5.9 W	153 lm/W	147 lm/W	135 lm/W	> 80
LLE G4 24x140mm 650lm 835 ADV	835/359	930 lm	890 lm	500 mA	11.1 V	12.9 V	5.9 W	156 lm/W	151 lm/W	139 lm/W	> 80
LLE G4 24x140mm 650lm 840 ADV	840/359	950 lm	910 lm	500 mA	11.1 V	12.9 V	5.9 W	160 lm/W	154 lm/W	142 lm/W	> 80
LLE G4 24x140mm 650lm 850 ADV	850/359	970 lm	920 lm	500 mA	11.1 V	12.9 V	5.9 W	163 lm/W	156 lm/W	144 lm/W	> 80
LLE G4 24x280mm 1250lm 827 ADV	827/359	1,720 lm	1,640 lm	500 mA	22.1 V	25.4 V	11.8 W	144 lm/W	139 lm/W	128 lm/W	> 80
LLE G4 24x280mm 1250lm 830 ADV	830/359	1,820 lm	1,730 lm	500 mA	22.1 V	25.4 V	11.8 W	153 lm/W	147 lm/W	135 lm/W	> 80
LLE G4 24x280mm 1250lm 835 ADV	835/359	1,860 lm	1,780 lm	500 mA	22.1 V	25.4 V	11.8 W	156 lm/W	151 lm/W	139 lm/W	> 80
LLE G4 24x280mm 1250lm 840 ADV	840/359	1,910 lm	1,810 lm	500 mA	22.1 V	25.4 V	11.8 W	160 lm/W	154 lm/W	142 lm/W	> 80
LLE G4 24x280mm 1250lm 850 ADV	850/359	1,940 lm	1,840 lm	500 mA	22.1 V	25.4 V	11.8 W	163 lm/W	156 lm/W	144 lm/W	> 80
LLE G4 24x280mm 1250lm 865 ADV	865/359	1,920 lm	1,810 lm	500 mA	22.1 V	25.4 V	11.8 W	161 lm/W	154 lm/W	142 lm/W	> 80
LLE G4 24x560mm 2400lm 827 ADV	827/359	3,430 lm	3,280 lm	500 mA	44.2 V	50.8 V	23.6 W	144 lm/W	139 lm/W	128 lm/W	> 80
LLE G4 24x560mm 2400lm 830 ADV	830/359	3,640 lm	3,470 lm	500 mA	44.2 V	50.8 V	23.6 W	153 lm/W	147 lm/W	135 lm/W	> 80
LLE G4 24x560mm 2400lm 835 ADV	835/359	3,720 lm	3,550 lm	500 mA	44.2 V	50.8 V	23.6 W	156 lm/W	151 lm/W	139 lm/W	> 80
LLE G4 24x560mm 2400lm 840 ADV	840/359	3,810 lm	3,620 lm	500 mA	44.2 V	50.8 V	23.6 W	160 lm/W	154 lm/W	142 lm/W	> 80
LLE G4 24x560mm 2400lm 850 ADV	850/359	3,890 lm	3,680 lm	500 mA	44.2 V	50.8 V	23.6 W	163 lm/W	156 lm/W	144 lm/W	> 80
LLE G4 24x560mm 2400lm 865 ADV	865/359	3,830 lm	3,620 lm	500 mA	44.2 V	50.8 V	23.6 W	161 lm/W	154 lm/W	142 lm/W	> 80

[Ⓐ] Integral measurement over the complete module,

[Ⓢ] If mounted with M4 screws and plastic washers,

[Ⓢ] Measured at operating mode HO,

[Ⓢ] HE „, high efficiency, NM „, nominal mode, HO „, high output,

[Ⓢ] Tolerance range for optical and electrical data: ±10 %,

Product description

- LINEAR COVER for LLE 24
- Protection against direct touch for non-SELV applications
- Fast snap on mounting on to LLE 24 with clips or plastic washers
- High transmission: transparent 94 %, semi-transparent 87 %, diffuse 76 %
- Made of PMMA
- Tolerances: ± 1 mm for 597 mm length (ends finished),
+ 20 mm for 1,200 / 1,500 / 1,600 / 1,800 mm length (ends raw)

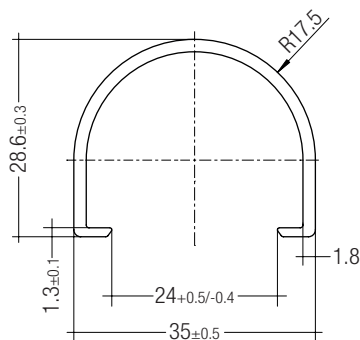
**Ordering data**

Type	Article number	Colour	Length	Packaging carton	Weight per pc.
LINEAR COVER SY Transparent 1600mm	28000338	Transparent	1,600 mm	12 pc(s).	0.272 kg
LINEAR COVER SY Frosted 1800mm	28000437	Semi-transparent	1,800 mm	12 pc(s).	0.308 kg
LINEAR COVER SY Frosted 1600mm	28000339	Semi-transparent	1,600 mm	12 pc(s).	0.272 kg
LINEAR COVER SY Frosted 1500mm	28000435	Semi-transparent	1,500 mm	12 pc(s).	0.244 kg
LINEAR COVER SY Frosted 1200mm	28000422	Semi-transparent	1,200 mm	12 pc(s).	0.205 kg
LINEAR COVER SY Frosted 597mm	28000340	Semi-transparent	597 mm	12 pc(s).	0.102 kg
LINEAR COVER SY Diffuse 1800mm	28000438	Diffuse	1,800 mm	12 pc(s).	0.308 kg
LINEAR COVER SY Diffuse 1600mm	28000341	Diffuse	1,600 mm	12 pc(s).	0.272 kg
LINEAR COVER SY Diffuse 1500mm	28000436	Diffuse	1,500 mm	12 pc(s).	0.257 kg
LINEAR COVER SY Diffuse 1200mm	28000434	Diffuse	1,200 mm	12 pc(s).	0.205 kg
LINEAR COVER SY Diffuse 597mm	28000342	Diffuse	597 mm	12 pc(s).	0.102 kg

ACL ENDCAP LLE24 PUSH-FIX

Product description

- ENDCAP for LLE 24
- Fast snap on mounting (sheet thickness 0.5 – 1.0 mm), for drilling hole 4 mm
- Made of Polycarbonat

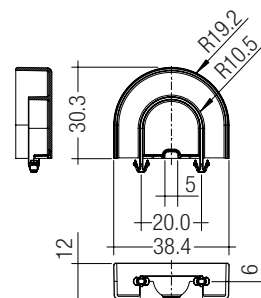

Ordering data

Type	Article number	Colour	Packaging carton	Weight per pc.
ACL ENDCAP LLE24 PUSH-FIX	28001037	White	480 pc(s).	0.003 kg

LINEAR LENS

Product description

- Linear lens for LLE 24
- Available in 60° and 90° light distribution
- Protection against direct touch for non-SELV applications
- Fast snap on mounting on to LLE 24 with clips or plastic washers
- High transmission: semi-transparent 97 %
- Linear lense made of PMMA
- Tolerances: ± 20 mm for 1,600 mm length (ends raw)

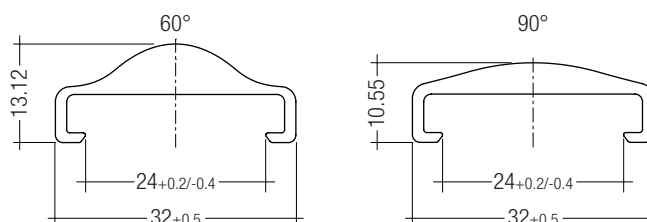

Ordering data

Type	Article number	Colour	Length	Packaging carton	Weight per pc.
ACL LINEAR LENS 24x1200mm 60°	28001428	Semi-transparent	1,200 mm	21 pc(s).	0.196 kg
ACL LINEAR LENS 24x1200mm 90°	28001429	Semi-transparent	1,200 mm	21 pc(s).	0.165 kg
ACL LINEAR LENS 24x1600mm 60°	28000953	Semi-transparent	1,600 mm	21 pc(s).	0.261 kg
ACL LINEAR LENS 24x1600mm 90°	28000955	Semi-transparent	1,600 mm	21 pc(s).	0.221 kg

CLIP 4.3mm

Product description

- Clip for fixation of LED modules with 4.3 mm holes
- Fast snap on mounting (sheet thickness 0.5 – 1.0 mm)
- For drilling hole 4 mm
- Clip made of Polycarbonat

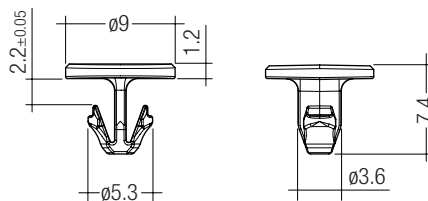

Ordering data

Type	Article number	Colour	Packaging bag [®]	Weight per pc.
ACL CLIP 4.3mm PUSH-FIX	28001036	White	500 pc(s).	0.001 kg

[®] Minimum sales quantity 500 pcs.

BRIDGE LLE24/40

Product description

- Enables the fixation of 24 mm wide Tridonic LED modules to fixtures made for 40 mm wide modules
- Ideal for extruded aluminium gear trays made for 40 mm modules with pre-alignment knobs
- Clip-on for LINEAR COVER and LINEAR LENS[®]
- For LLE 24 with 280 mm module minimum 2 bridges required
- For LLE 24 with 560 mm module minimum 3 bridges required
- Fixation via M3 or M4 countersunk screw, max. tightening torque 0.5 Nm
- BRIDGE made of white polycarbonate

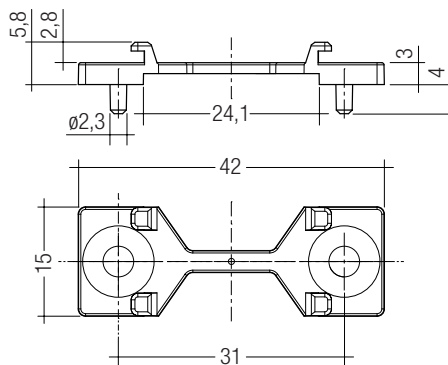

Ordering data

Type	Article number	Colour	Packaging carton [®]	Weight per pc.
ACL BRIDGE LLE24/40 SCREW-FIX	28001205	White	600 Stk.	0.001 kg

[®] Minimum sales quantity 600 pcs.

[®] Beam characteristics will change due to the elevated fixation (see photometric files for details).

1. Standards

IEC 62031
IEC 62471
IEC 61000-4-2

1.1 Photometric code

Key for photometric code, e. g. 830 / 349

1 st digit	2 nd + 3 rd digit	4 th digit	5 th digit	6 th digit		
Code	Colour temperature in Kelvin x 100	McAdam initial	McAdam after 25% of the life-time (max.6000h)	Luminous flux after 25% of the life-time (max.6000h)		
				Code	Luminous flux	
7				70 – 79	7	≥ 70 %
8				80 – 89	8	≥ 80 %
9	≥90			9	≥ 90 %	

1.2 Energy classification

Typ	Energieklassifizierung
LLE G4 24mm ADV	A++

2. Thermal details

2.1 tc point, ambient temperature and life-time

The temperature at tp reference point is crucial for the light output and life-time of a LED product.

For LLE a tp temperature of 65 °C has to be complied in order to achieve an optimum between heat sink requirements, light output and life-time.

Compliance with the maximum permissible reference temperature at the tc point must be checked under operating conditions in a thermally stable state. The maximum value must be determined under worst-case conditions for the relevant application.

The tc and tp temperature of LED modules from Tridonic are measured at the same reference point.

2.2 Storage and humidity

Storage temperature	-40 ... +100 °C
---------------------	-----------------

Operation only in non condensing environment.
Humidity during processing of the module should be between 0 to 60 %.

2.3 Thermal design and heat sink

The rated life of LED products depends to a large extent on the temperature. If the permissible temperature limits are exceeded, the life of the LLE will be greatly reduced or the LLE may be destroyed.

2.4 Heat sink values

LLE G4 24x140mm 650lm 8xx ADV

ta	tp	Forward current	R _{th, hs-a}	Cooling area
25 °C	65 °C	325 mA		self cooling
25 °C	65 °C	400 mA		self cooling
35 °C	65 °C	325 mA		self cooling
35 °C	65 °C	400 mA		self cooling
45 °C	65 °C	325 mA	8.9 K/W	75 cm ²
45 °C	65 °C	400 mA	6.7 K/W	100 cm ²

LLE G4 24x280mm 1250lm 8xx ADV

ta	tp	Forward current	R _{th, hs-a}	Cooling area
25 °C	65 °C	325 mA		self cooling
25 °C	65 °C	400 mA		self cooling
35 °C	65 °C	325 mA		self cooling
35 °C	65 °C	400 mA		self cooling
45 °C	65 °C	325 mA	4.8 K/W	138 cm ²
45 °C	65 °C	400 mA	3.4 K/W	195 cm ²

LLE G4 24x560mm 2400lm 8xx ADV

ta	tp	Forward current	R _{th, hs-a}	Cooling area
25 °C	65 °C	325 mA		self cooling
25 °C	65 °C	400 mA		self cooling
35 °C	65 °C	325 mA		self cooling
35 °C	65 °C	400 mA		self cooling
45 °C	65 °C	325 mA	2.4 K/W	276 cm ²
45 °C	65 °C	400 mA	1.8 K/W	371 cm ²

Notes

The actual cooling surface can differ because of the material, the structural shape, outside influences and the installation situation. Depending on the heat sink a heat conducting paste or heat conducting film might be necessary to keep the specified tp temperature.

3. Installation / wiring

3.1 Electrical supply/choice of LED Driver

LLE modules from Tridonic are not protected against overvoltages, overcurrents, overloads or short-circuit currents. Safe and reliable operation can only be guaranteed in conjunction with a LED Driver which complies with the relevant standards. The use of LED Driver from Tridonic in combination with LLE modules guarantees the necessary protection for safe and reliable operation.

If a LED Driver other than Tridonic is used, it must provide the following protection:

- Short-circuit protection
- Overload protection
- Overtemperature protection



LLE modules must be supplied by a constant current LED Driver. Operation with a constant voltage LED Driver will lead to an irreversible damage of the module.

Wrong polarity can damage the LLE.

With parallel wiring tolerance-related differences in output are possible (thermal stress of the module) and can cause differences in brightness. Not more than three LLE G4 24x560mm ADV or six LLE G4 4x280mm ADV are allowed to be connected in parallel. It is also recommended to use the functionality of the double terminal (internal loop through for parallel wiring) only for two LLE G4 24x560mm ADV or four LLE G4 24x280mm ADV (see wiring examples).

For parallel wiring only modules of the same forward voltage bin may be used.

The forward voltage bin indicated on the label of the module.

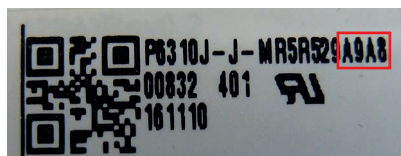

If a wire breaks or a complete module fails then the current passing through the other module increases. This may reduce its life considerably.

TALEXmodule LLE can be operated either from SELV LED Drivers or from LED Drivers with LV output voltage.



TALEXmodule LLE are basic isolated up to 320 V (if mounted with M4 screws with head diameter 7 mm in combination with plastic washers) against ground and can be mounted directly on earthed metal parts of the luminaire. If the max. output voltage of the LED Driver (also against earth) is above 320 V, an additional isolation between LED module and heat sink is required (for example by isolated thermal pads) or by a suitable luminaire construction.

At voltages > 60 V an additional protection against direct touch (test finger) to the light emitting side of the module has to be guaranteed. This is typically achieved by means of a non removable light distributor over the module.

LED Driver for parallel wiring

LED module	Forward current	LCA 45W 500-1400mA one4all SR PRE	LCA 50W 350-1050mA one4all Ip PRE	LCA 75W 900-1800mA one4all Ip PRE
LLE G4 24x280mm 1250lm 4T ADV	225 mA	2 modules in series x 3 – 4 ^①	1 module in series x 2 – 4	1 module in series x 4 – 8
	275 mA	2 modules in series x 2 – 3 ^①	1 module in series x 2 – 3	1 module in series x 4 – 6
	300 mA	2 modules in series x 2 – 3 ^①	1 module in series x 2 – 3	1 module in series x 3 – 6
	325 mA	2 modules in series x 2 ^①	1 module in series x 2 – 3	1 module in series x 3 – 5
	350 mA	2 modules in series x 2 ^①	1 module in series x 2 – 3	1 module in series x 3 – 5
	400 mA	–	1 module in series x 2	1 module in series x 3 – 4
	450 mA	–	1 module in series x 2	1 module in series x 2 – 4
	500 mA	1 module in series x 2	1 module in series x 2	1 module in series x 2 – 3
LLE G4 24x560mm 2400lm 4T ADV	225 mA	1 module in series x 3 – 4 ^①	1 module in series x 2 – 4 ^①	1 module in series x 4 – 6 ^①
	275 mA	1 module in series x 2 – 3 ^①	1 module in series x 2 – 3 ^①	1 module in series x 4 – 5 ^①
	300 mA	1 module in series x 2 – 3 ^①	1 module in series x 2 – 3 ^①	1 module in series x 3 – 5 ^①
	325 mA	1 module in series x 2 ^①	1 module in series x 2 – 3 ^①	1 module in series x 3 – 4 ^①
	350 mA	1 module in series x 2 ^①	1 module in series x 2 ^①	1 module in series x 3 – 4 ^①
	400 mA	–	–	–
	450 mA	–	–	–
	500 mA	–	–	–

^① Upgrade of LED Driver is necessary to work reliable at low temperatures for this combination. This will be realised in July 2016.

3.2 Wiring

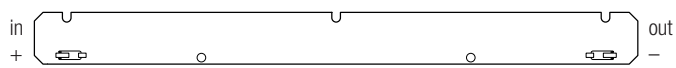

Wiring examples

Serial wiring:

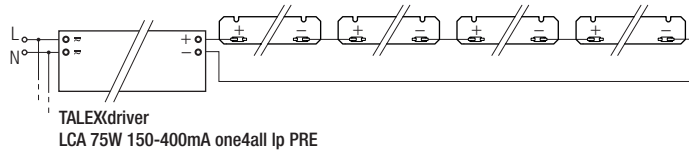

Parallel wiring:

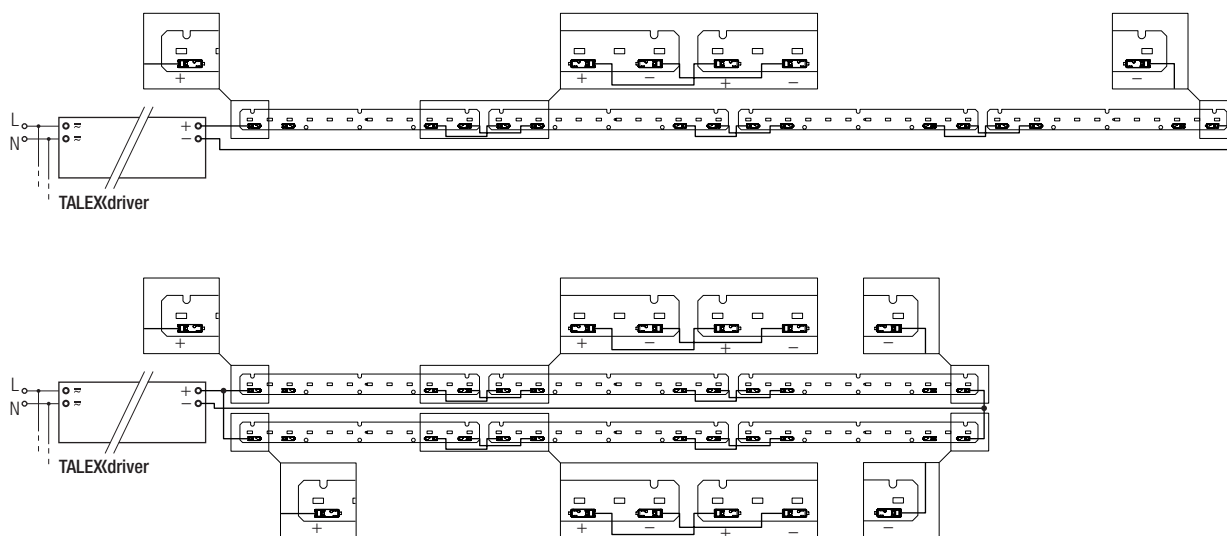

3.3 Wiring type and cross section

The wiring can be in stranded wires or solid with a cross section of 0.2 to 0.75 mm².

For the push-wire connection you have to strip the insulation (8-9 mm).

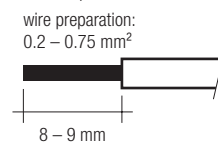

To remove the wires use a suitable tool (e.g. Microcon release pin) or through twist and pull.

3.4 Mounting instruction



None of the components of the LLE (substrate, LED, electronic components etc.) may be exposed to tensile or compressive stresses.

Max. torque for fixing: 0.5 Nm.

The LED modules are mounted onto a heat sink with min. 3 screws per module or ACL CLIP 4.3mm.



Chemical substance may harm the LED module. Chemical reactions could lead to colour shift, reduced luminous flux or a total failure of the module caused by corrosion of electrical connections.

Materials which are used in LED applications (e.g. sealings, adhesives) must not produce dissolver gas. They must not be condensation curing based, acetate curing based or contain sulfur, chlorine or phthalate.

Avoid corrosive atmosphere during usage and storage.

3.5 EOS/ESD safety guidelines



The device / module contains components that are sensitive to electrostatic discharge and may only be installed in the factory and on site if appropriate EOS/ESD protection measures have been taken. No special measures need be taken for devices/modules with enclosed casings (contact with the pc board not possible), just normal installation practice. Please note the requirements set out in the document EOS / ESD guidelines (Guideline_EOS_ESD.pdf) at: <http://www.tridonic.com/esd-protection>

4. Life-time

4.1 Life-time, lumen maintenance and failure rate

The light output of an LED Module decreases over the life-time, this is characterized with the L value.

L70 means that the LED module will give 70 % of its initial luminous flux. This value is always related to the number of operation hours and therefore defines the life-time of an LED module.

As the L value is a statistical value and the lumen maintenance may vary over the delivered LED modules.

The B value defines the amount of modules which are below the specific L value, e.g. L70B10 means 10 % of the LED modules are below 70 % of the initial luminous flux, respectively 90 % will be above 70 % of the initial value. In addition the percentage of failed modules (fatal failure) is characterized by the C value.

The F value is the combination of the B and C value. That means for F degradation and complete failures are considered, e.g. L70F10 means 10 % of the LED modules may fail or be below 70 % of the initial luminous flux.

Life-time declarations are informative and represent no warranty claim.

4.2 Lumen maintenance for LLE G4 24mm ADV

Forward current	tp tempera- ture	tp					
		L90 / F10	L90 / F50	L80 / F10	L80 / F50	L70 / F10	L70 / F50
100 mA	45 °C	38,000 h	43,000 h	>60,000 h	>60,000 h	>60,000 h	>60,000 h
	55 °C	35,000 h	40,000 h	>60,000 h	>60,000 h	>60,000 h	>60,000 h
	65 °C	30,000 h	34,000 h	>60,000 h	>60,000 h	>60,000 h	>60,000 h
150 mA	45 °C	26,000 h	29,000 h	54,000 h	>60,000 h	>60,000 h	>60,000 h
	55 °C	37,000 h	43,000 h	>60,000 h	>60,000 h	>60,000 h	>60,000 h
	65 °C	30,000 h	34,000 h	>60,000 h	>60,000 h	>60,000 h	>60,000 h
200 mA	45 °C	29,000 h	32,000 h	58,000 h	>60,000 h	>60,000 h	>60,000 h
	55 °C	34,000 h	38,000 h	>60,000 h	>60,000 h	>60,000 h	>60,000 h
	65 °C	25,000 h	28,000 h	51,000 h	57,000 h	>60,000 h	>60,000 h
225 mA	45 °C	37,000 h	42,000 h	>60,000 h	>60,000 h	>60,000 h	>60,000 h
	55 °C	33,000 h	37,000 h	>60,000 h	>60,000 h	>60,000 h	>60,000 h
	65 °C	28,000 h	31,000 h	55,000 h	>60,000 h	>60,000 h	>60,000 h
275 mA	45 °C	23,000 h	26,000 h	48,000 h	54,000 h	>60,000 h	>60,000 h
	55 °C	37,000 h	42,000 h	>60,000 h	>60,000 h	>60,000 h	>60,000 h
	65 °C	27,000 h	30,000 h	54,000 h	>60,000 h	>60,000 h	>60,000 h
325 mA	45 °C	23,000 h	25,000 h	46,000 h	52,000 h	>60,000 h	>60,000 h
	55 °C	36,000 h	41,000 h	>60,000 h	>60,000 h	>60,000 h	>60,000 h
	65 °C	31,000 h	36,000 h	>60,000 h	>60,000 h	>60,000 h	>60,000 h
400 mA	45 °C	26,000 h	29,000 h	51,000 h	59,000 h	>60,000 h	>60,000 h
	55 °C	21,000 h	24,000 h	43,000 h	48,000 h	>60,000 h	>60,000 h
	65 °C	18,000 h	20,000 h	40,000 h	45,000 h	>60,000 h	>60,000 h
450 mA	45 °C	36,000 h	40,000 h	>60,000 h	>60,000 h	>60,000 h	>60,000 h
	55 °C	30,000 h	34,000 h	58,000 h	>60,000 h	>60,000 h	>60,000 h
	65 °C	25,000 h	27,000 h	48,000 h	56,000 h	>60,000 h	>60,000 h
500 mA	45 °C	20,000 h	22,000 h	40,000 h	45,000 h	>60,000 h	>60,000 h
	55 °C	29,000 h	33,000 h	55,000 h	>60,000 h	>60,000 h	>60,000 h
	65 °C	23,000 h	25,000 h	44,000 h	51,000 h	>60,000 h	>60,000 h
	45 °C	18,000 h	19,000 h	35,000 h	40,000 h	59,000 h	>60,000 h
	55 °C	35,000 h	40,000 h	>60,000 h	>60,000 h	>60,000 h	>60,000 h
	65 °C	28,000 h	32,000 h	53,000 h	60,000 h	>60,000 h	>60,000 h
	45 °C	21,000 h	23,000 h	41,000 h	48,000 h	>60,000 h	>60,000 h
	55 °C	16,000 h	18,000 h	32,000 h	36,000 h	54,000 h	>60,000 h
	65 °C	15,000 h	16,000 h	29,000 h	32,000 h	49,000 h	56,000 h

5. Electrical values

5.1 Declaration of electrical parameters

Irated ... Nominal operating current the module is designed for.

I_{max} ... Max. permissible continuous operating current.

Max. DC forward current ... Max. permissible continuous operating current incl. The tolerances of the LED driver. LED module may be destroyed if this value is exceeded.

Max. permissible LF current ripple ... Max. output current of the LED driver incl. Tolerances and LF current ripple must not exceed this value.

Max. permissible peak current ... The max. output peak current of the LED driver must not exceed this value.

5.2 Typ. forward voltage vs. forward current

LLE G4 24x140mm 650lm 8xx ADV

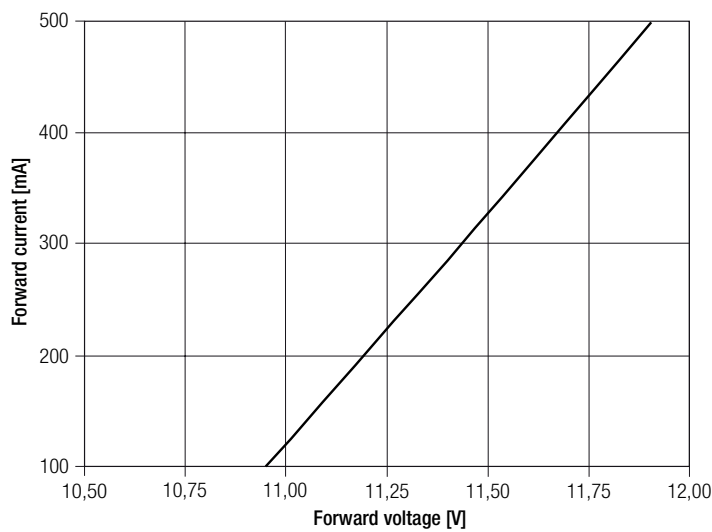

LLE G4 24x280mm 1250lm 8xx ADV

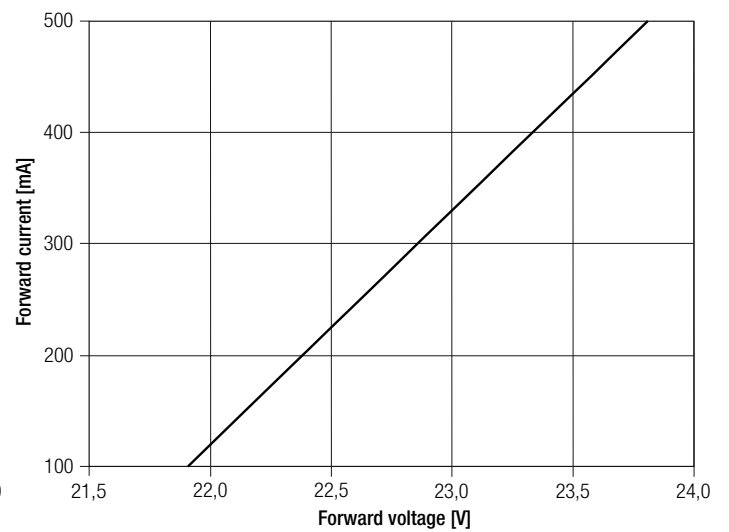

LLE G4 24x560mm 2400lm 8xx ADV

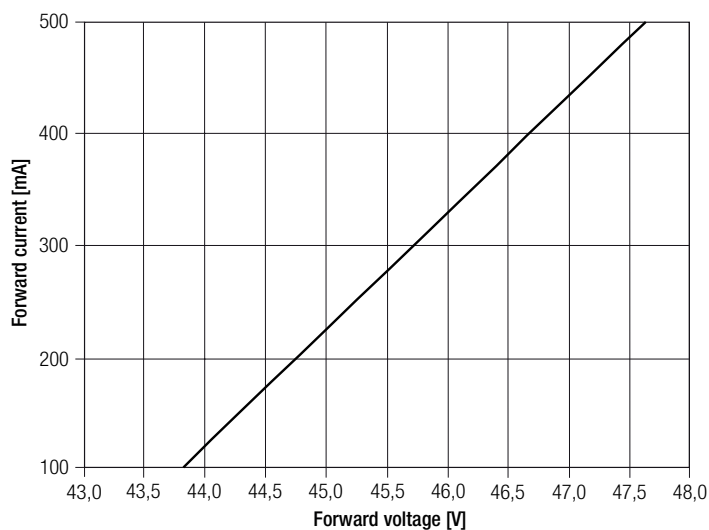

5.3 Forward voltage vs. tc temperature

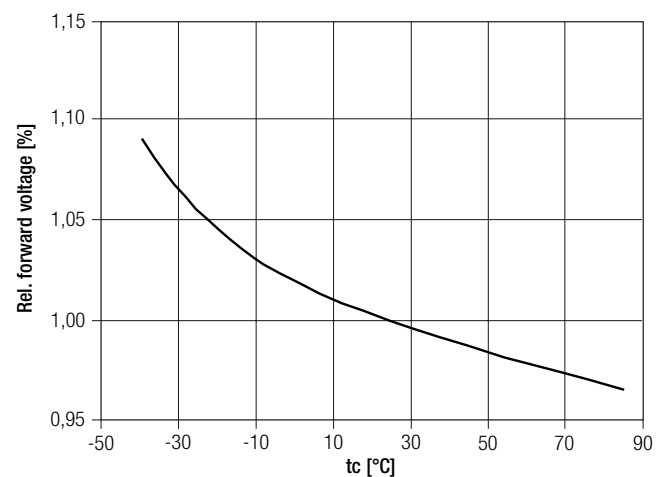

The diagrams are based on statistic values.
The real values can be different.

6. Photometric characteristics

6.1 Coordinates and tolerances according to CIE 1931

The specified colour coordinates are integral measured by current impulse of 325 mA and a duration of 100 ms.

The ambient temperature of the measurement is $t_a = 25^\circ\text{C}$.

The measurement tolerance of the colour coordinates are ± 0.01 .

2,700 K

	x0	y0
Centre	0.4578	0.4093

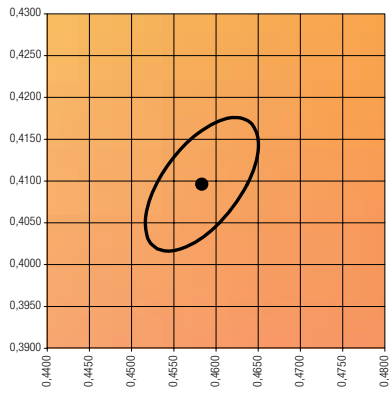

— MacAdam Ellipse: 3SDCM

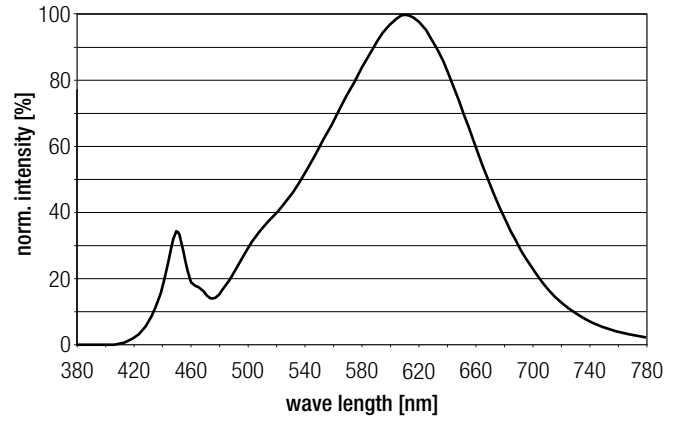

3,000 K

	x0	y0
Centre	0.4340	0.4026

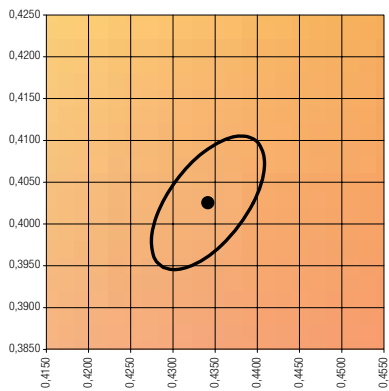

— MacAdam Ellipse: 3SDCM

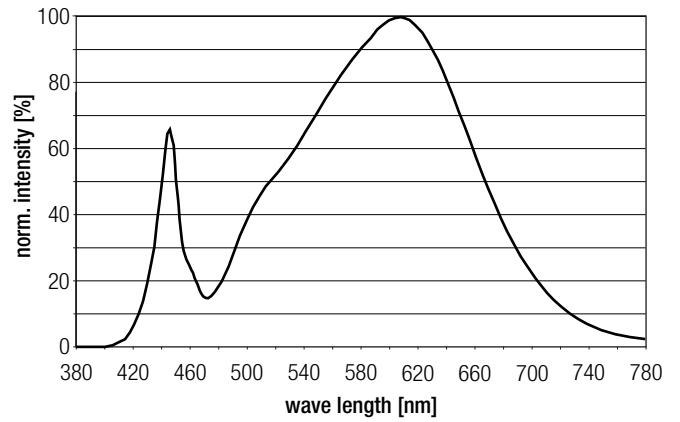

3,500 K

	x0	y0
Center	0.4078	0.3917

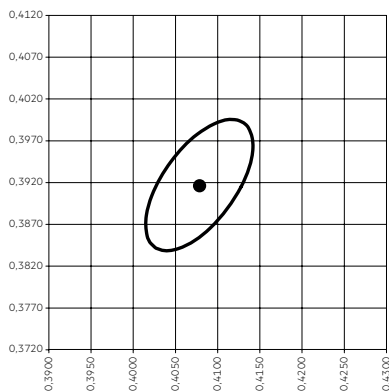

— MacAdam Ellipse: 3SDCM

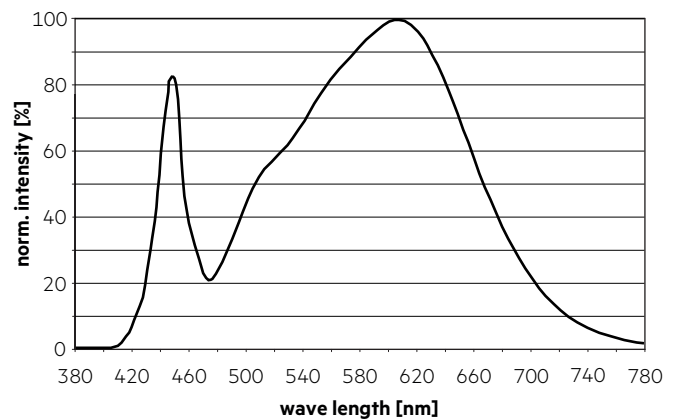

4,000 K

	x0	y0
Center	0.3822	0.3794

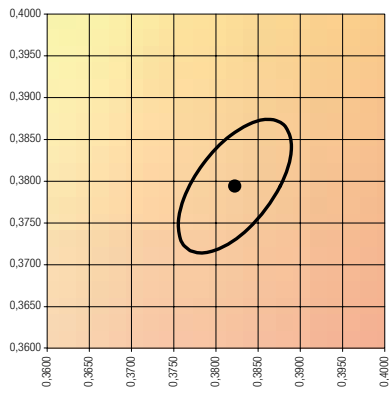

— MacAdam Ellipse: 3SDCM

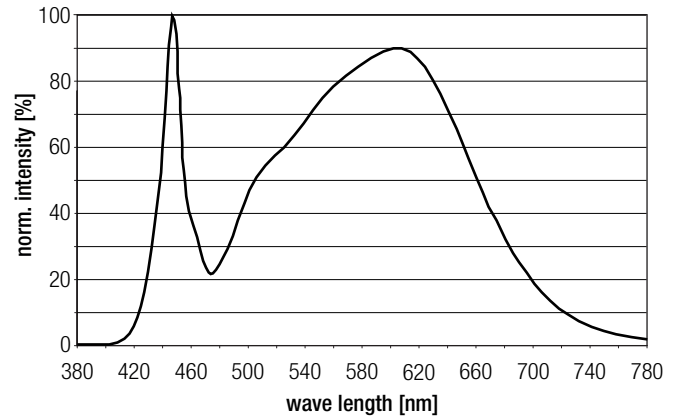

5,000 K

	x0	y0
Center	0.3447	0.3547

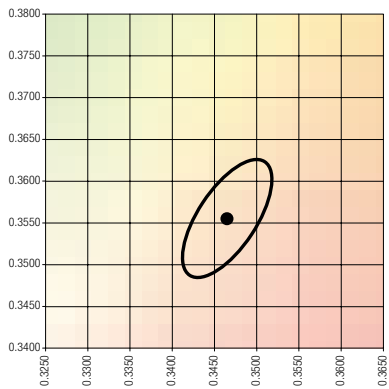

— MacAdam Ellipse: 3SDCM

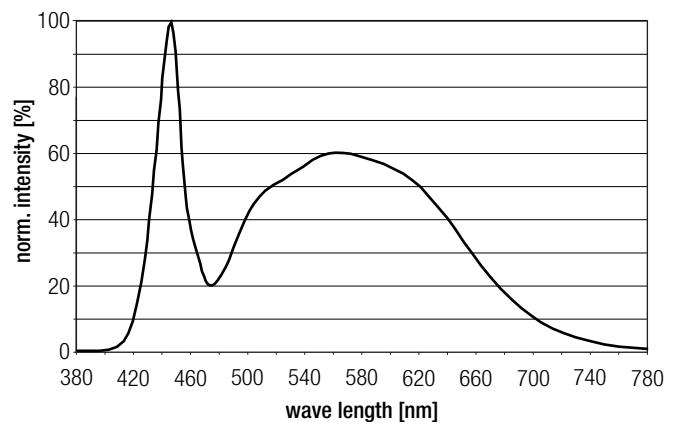

6,500 K

	x0	y0
Center	0.3126	0.3280

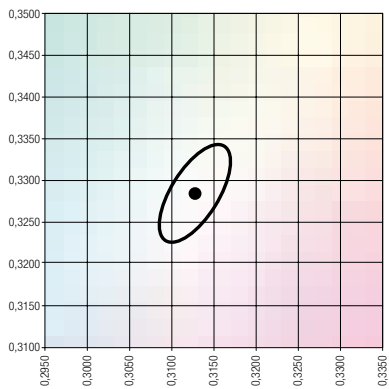

— MacAdam Ellipse: 3SDCM

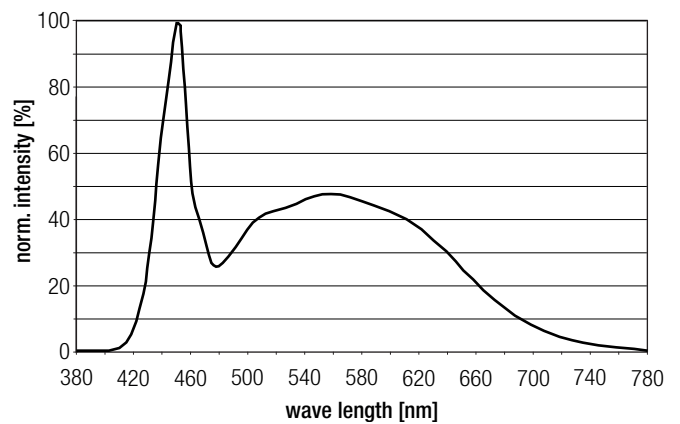

6.2 Light distribution

The optical design of the LLE product line ensures optimum homogeneity for the light distribution.

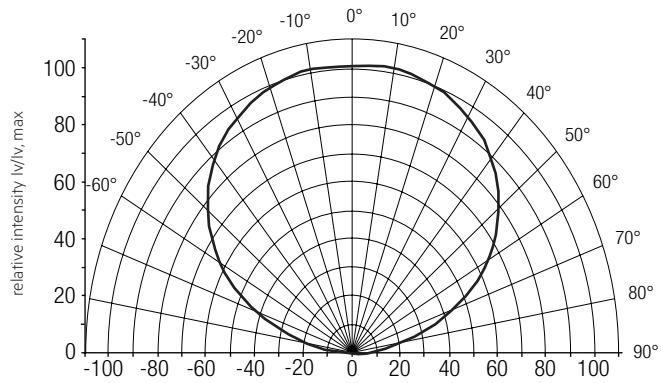

The colour temperature is measured integral over the complete module. The single LED light points can have deviations in the colour coordinates within MacAdam 3. To ensure an ideal mixture of colours and a homogenous light distribution a suitable optic (e. g. PMMA diffuser) and a sufficient spacing between module and optic (typ. 4 cm) should be used.

6.4 Relative luminous flux vs. operating current

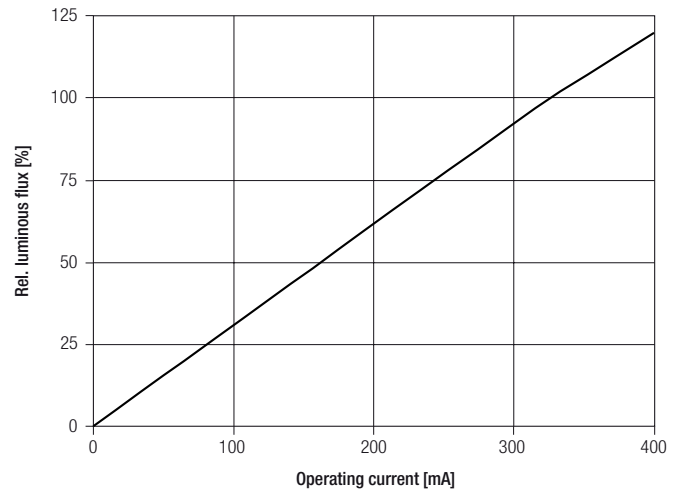

The diagrams are based on statistic values. The real values can be different.

For further information see Design-in Guide, 3D data and photometric data on www.tridonic.com or on request.

6.3 Relative luminous flux vs. tc temperature

