



Driver LCAI 15W 150mA–400mA ECO slim

ECO series

Product description

- Independent dimmable LED Driver
- Constant current LED Driver
- Output current adjustable between 150 – 400 mA
- Max. output power 15 W
- Nominal life-time up to 100,000 h
- Dimming range 1 ... 100 %
- Pluggable LED connector (note that the connection cable is not within the scope of supply and needs to be ordered separately, see accessory)
- 5-year guarantee

Properties

- Casing: polycarbonate, white
- Type of protection IP20

Interfaces

- DALI DEVICE Type 6
- DSI
- switchDIM (with memory function)
- corridorFUNCTION

Functions

- Adjustable output current (I-select resistor or DALI)
- Power-up fading at AC
- Intelligent Temperature Guard (overtemperature protection)
- Short-circuit proof
- Overload protection
- Constant Light Output function
- Suitable for emergency escape lighting systems acc. to EN50172



Standards, page 4

IP20 SELV          
RoHS

Driver LCAI 15W 150mA–400mA ECO slim ECO series

Technical data

Rated supply voltage	220 – 240 V
AC voltage range	198 – 264 V
DC voltage range	176 – 280 V
Mains frequency	0 / 50 / 60 Hz
Overvoltage protection	320 V AC, 48 h
Typ. current (at 230 V, 50 Hz, full load) [Ⓜ]	875 mA
Typ. current (220 V, 0 Hz, full load, 15 % dimming level) [Ⓜ]	15 mA
Leakage current (PE)	< 580 µA
Max. input power	18.5 W
Typ. efficiency (at 230 V / 50 Hz / full load) [Ⓜ]	83 %
λ (at 230 V, 50 Hz, full load) [Ⓜ]	0.89C
Typ. power input on stand-by [Ⓜ]	190 mW
THD (at 230 V, 50 Hz, full load)	< 6.5 %
Time to light (at 230 V, 50 Hz, full load, acc. to DALI)	< 0.6 s
Time to light (DC mode)	< 0.4 s
Switchover time (AC/DC)	< 0.4 s
Turn off time (at 230 V, 50 Hz, full load)	< 50 ms
Hold on time (at 230 V, 50 Hz, full load) [Ⓜ]	15 ms
Output current tolerance [Ⓜ]	± 3 %
Output LF current ripple (< 120 Hz)	< 2 %
Max. peak output current	≤ output current + 18 %
PWM frequency [Ⓜ]	500 Hz
Dimming range	1 – 100 %
Max. output voltage	60 V
Burst / surge peaks output side against PE	< 500 V
Dimensions L x W x H	145 x 51 x 29.5 mm

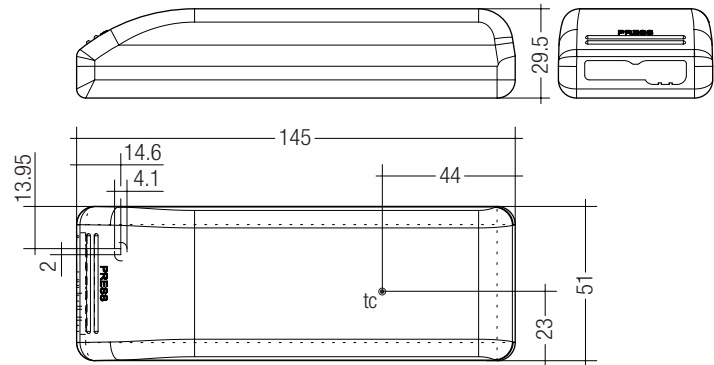

Ordering data

Type	Article number	Packaging carton	Packaging pallet	Weight per pc.
LCAI 15W 150mA-400mA ECO slim	28000445	10 pc(s).	700 pc(s).	0.126 kg

Specific technical data

Type	Output current [Ⓜ]	Min. forward voltage	Max. forward voltage [Ⓜ]	Max. output power [Ⓜ]	Typ. power consumption (at 230 V, 50 Hz, full load)	Typ. current consumption (at 230 V, 50 Hz, full load)	Max. casing temperature tc	Ambient temperature ta max.	I-select resistor value
	150 mA	23 V	50 V	7.5 W	9.4 W	55.6 mA	75 °C	-25 ... +65 °C	open
	175 mA	23 V	50 V	8.8 W	10.8 W	60.7 mA	75 °C	-25 ... +65 °C	63.40 kΩ
	200 mA	23 V	50 V	10.0 W	12.2 W	65.9 mA	75 °C	-25 ... +65 °C	54.90 kΩ
	225 mA	23 V	50 V	11.3 W	13.6 W	71.0 mA	75 °C	-25 ... +65 °C	47.50 kΩ
	250 mA	23 V	50 V	12.5 W	15.0 W	76.2 mA	75 °C	-25 ... +60 °C	40.20 kΩ
LCAI 15W 150mA-400mA ECO slim	275 mA	23 V	50 V	13.8 W	16.4 W	81.4 mA	75 °C	-25 ... +60 °C	34.00 kΩ
	300 mA	23 V	50 V	15.0 W	17.8 W	86.5 mA	75 °C	-25 ... +60 °C	27.40 kΩ
	325 mA	21 V	46 V	15.0 W	17.8 W	86.5 mA	75 °C	-25 ... +60 °C	22.00 kΩ
	350 mA	19 V	43 V	15.0 W	17.8 W	86.8 mA	75 °C	-25 ... +60 °C	12.00 kΩ
	375 mA	18 V	40 V	15.0 W	17.9 W	87.0 mA	75 °C	-25 ... +60 °C	6.19 kΩ
	400 mA	17 V	38 V	15.0 W	18.0 W	87.5 mA	75 °C	-25 ... +60 °C	short circuit (0 Ω)

[Ⓜ] Valid at 100 % dimming level.

[Ⓜ] Depending on the selected output current.

[Ⓜ] Depending on the DALI traffic at the interface.

[Ⓜ] At power failure.

[Ⓜ] ± 20 %.

[Ⓜ] At full load.

[Ⓜ] Output current is mean value.

I-SELECT PLUG TOP / ECO

Product description

- Ready-for-use resistor to set output current value
- Compatible with LED Driver series TOP and ECO
- Resistor is base isolated
- Resistor power 0.25 W
- Resistor value tolerance $\pm 1\%$

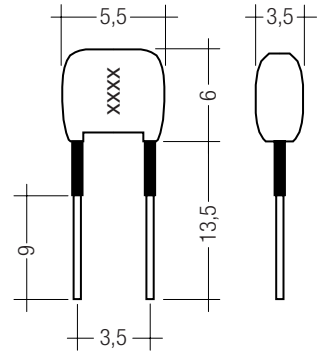
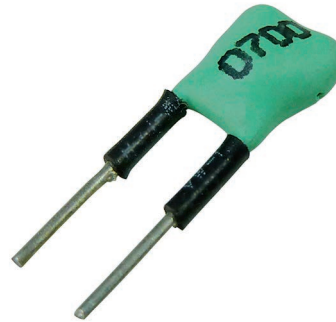

Ordering data

Type	Article number	Colour	Marking	Resistor value	Packaging bag	Weight per pc.
I-SELECT PLUG 175mA BL	28000446	Blue	0175	63.40 k Ω	10 pc(s).	0.001 kg
I-SELECT PLUG 200mA BL	28000447	Blue	0200	54.90 k Ω	10 pc(s).	0.001 kg
I-SELECT PLUG 225mA BL	28000448	Blue	0225	47.50 k Ω	10 pc(s).	0.001 kg
I-SELECT PLUG 250mA BL	28000368	Blue	0250	40.20 k Ω	10 pc(s).	0.001 kg
I-SELECT PLUG 275mA BL	28000369	Blue	0275	34.00 k Ω	10 pc(s).	0.001 kg
I-SELECT PLUG 300mA BL	28000275	Blue	0300	27.40 k Ω	10 pc(s).	0.001 kg
I-SELECT PLUG 325mA BL	28000449	Blue	0325	22.00 k Ω	10 pc(s).	0.001 kg
I-SELECT PLUG 350mA BL	28000276	Blue	0350	12.00 k Ω	10 pc(s).	0.001 kg
I-SELECT PLUG 375mA BL	28000450	Blue	0375	6.19 k Ω	10 pc(s).	0.001 kg
I-SELECT PLUG MAX GR	28000274	Grey	MAX	0 Ω	10 pc(s).	0.001 kg

LED connection cable 0.3m

Product description

- Connection cable 0.3 m to connect LCAI ECO slim to LED module
- Note that the connection cable is not within the scope of supply and needs to be ordered separately

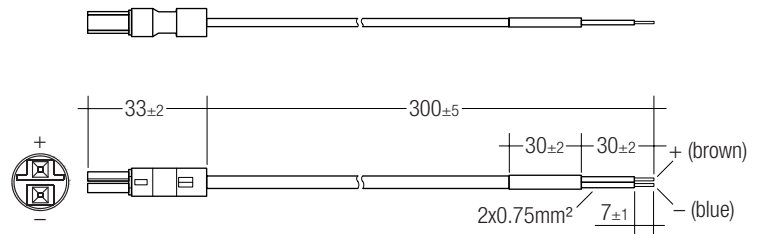

Ordering data

Type	Article number	Length	Packaging bag	Packaging carton	Weight per pc.
Slim gear connection cable 0.3m	28000639	0.3 m	25 pc(s).	1000 pc(s).	0.007 kg

Standards

EN 55015
 EN 61000-3-2
 EN 61000-3-3
 EN 61347-1
 EN 61347-2-13
 EN 62384
 EN 61547
 EN 62386-101 (according to DALI standard V1)
 EN 62386-102
 EN 62386-207
 According to EN 50172 for use in central battery systems
 According to EN 60598-2-22 suitable for emergency lighting installations

Overload protection

If the output voltage range is exceeded the LED Driver turns off the LED output. After restart of the LED Driver the output will be activated again. The restart can either be done via mains reset or via interface (DALI, DSI, switchDIM).

Overtemperature protection

The LED Driver is protected against temporary thermal overheating. If the temperature limit is exceeded the output current of the LED is reduced. The temperature protection is activated approx. +5 °C above t_c max (see page 2). On DC operation this function is deactivated to fulfill emergency requirements.

Short-circuit behaviour

In case of a short circuit at the LED output the LED output is switched off. After restart of the LED Driver the output will be activated again. The restart can either be done via mains reset or via interface (DALI, DSI, switchDIM).

No-load operation

The LED Driver will not be damaged in the no-load operation. The output will be deactivated and therefore free of voltage. If a LED load is connected the device has to be restarted before the output will be activated again.

Hot plug-in

Hot plug-in is not recommend within 5 s after shutdown due to output voltage of > 0 V. If a LED load is connected the device has to be restarted before the output will be activated again. This can be done with mains reset, DALI, DSI or switchDIM.

Conditions of use and storage

Humidity: 5 % up to max. 85 %, not condensed (max. 56 days/year at 85 %)

Storage temperature: -40 °C up to max. +80 °C

The devices have to be within the specified temperature range (t_a) before they can be operated.

Glow wire test

according to EN 61347-1 with increased temperature of 850 °C passed.

Expected life-time

Type	Output current	t_a	40 °C	50 °C	55 °C	60 °C	65 °C
150 – 225 mA		t_c	55 °C	65 °C	70 °C	75 °C	75 °C
		Life-time	> 100,000 h	> 100,000 h	> 100,000 h	70,000 h	55,000 h
LCAI 15W 150mA-400mA ECO slim	> 225 – 300 mA	t_c	60 °C	70 °C	70 °C	75 °C	x
		Life-time	> 100,000 h	> 100,000 h	80,000 h	60,000 h	x
> 300 – 400 mA		t_c	60 °C	70 °C	75 °C	75 °C	x
		Life-time	> 100,000 h	> 100,000 h	70,000 h	60,000 h	x

The LED Driver is designed for a life-time stated above under reference conditions and with a failure probability of less than 10 %.

Maximum loading of automatic circuit breakers

Automatic circuit breaker type	C10	C13	C16	C20	B10	B13	B16	B20
Installation Ø	1.5 mm ²	1.5 mm ²	2.5 mm ²	2.5 mm ²	1.5 mm ²	1.5 mm ²	2.5 mm ²	2.5 mm ²
LCAI 15W 150mA-400mA ECO slim	100	130	160	200	100	130	160	200

Note: No considerable inrush current, therefore the amount of devices per circuit breaker is restricted by max. input current.

Harmonic distortion in the mains supply (at 230 V / 50 Hz and full load) in %

	THD	3.	5.	7.	9.	11.
LCAI 15W 150mA-400mA ECO slim	12.8	8	5	5	4	3

Control input (DA/N, DA/L)

Digital DALI signal or switchDIM can be wired on the same terminals (DA/N and DA/L).

Digital signal DALI/DSI

The control input is non-polar for digital control signals (DALI, DSI). The control signal is not SELV. Control cable has to be installed in accordance to the requirements of low voltage installations.

Different functions depending on each module.

switchDIM

Integrated switchDIM function allows a direct connection of a push to make switch for dimming and switching.

Brief push (< 0.6 s) switches LED Driver ON and OFF. The LED Drivers switch-ON at light level set at switch-OFF.

When the push to make switch is held, LED modules are dimmed. After repush the LED modules are dimmed in the opposite direction.

In installations with LED Drivers with different dimming levels or opposite dimming directions (e.g. after a system extension), all LED Drivers can be synchronized to 50 % dimming level by a 10 s push.

Use of push to make switch with indicator lamp is not permitted.

corridorFUNCTION

The corridorFUNCTION can be programmed in two different ways.

To program the corridorFUNCTION by means of software a DALI-USB interface is needed in combination with a DALI PS. The software can be the masterCONFIGURATOR.

To activate the corridorFUNCTION without using software a voltage of 230 V simply has to be applied for five minutes at the switchDIM connection.

The unit will then switch automatically to the corridorFUNCTION.

Note:

If the corridorFUNCTION is wrongly activated in a switchDIM system (for example a switch is used instead of pushbutton), there is the option of installing a pushbutton and deactivating the corridorFUNCTION mode by five short pushes of the button within three seconds.

switchDIM and corridorFUNCTION are very simple tools for controlling ballasts with conventional momentary-action switches or motion sensors.

To ensure correct operation a sinusoidal mains voltage with a frequency of 50 Hz or 60 Hz is required at the control input.

Special attention must be paid to achieving clear zero crossings. Serious mains faults may impair the operation of switchDIM and corridorFUNCTION.

Dimming

Dimming range 1% to 100%

Digital control with:

- DSI signal: 8 bit Manchester Code
Speed 1% to 100% in 1.4 s
- DALI signal: 16 bit Manchester Code
Speed 1% to 100% in 0.2 s
Programmable parameter:
Minimum dimming level
Maximum dimming level
Default minimum = 1%
Programmable range $1\% \leq \text{MIN} \leq 100\%$
Default maximum = 100%
Programmable range $100\% \geq \text{MAX} \geq 1\%$

Dimming curve is adapted to the eye sensitiveness.

Dimming is realized by a combination of analog amplitude dimming and PWM dimming.

35 ... 100 %: amplitude dimming

1 ... 34 %: PWM dimming

Dimming characteristics

Digital dimming value

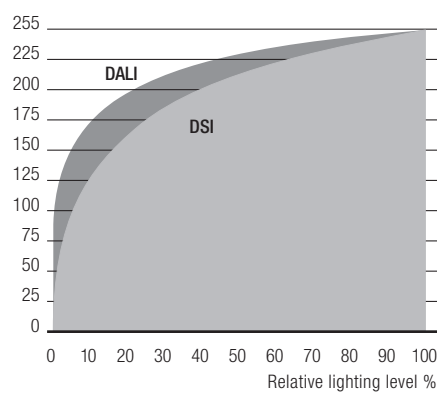

Dimming characteristics as seen by the human eye

Light level in DC operation

Light output level in DC operation: programmable 1 – 100 % (EOF_i = 0.13).

Programming by extended DSI or DALI signal (16 bit).

Default value is 15 %

In DC operation dimming mode can be activated.

Function: adjustable current (I-select)

The output current of the LED Driver can be selected between 150 and 400 mA. For adjustment there are two options available.

Option 1: „I-select resistor“

In 25 mA steps adjustable (see page 2, specific technical data, „I-select resistor value“).

Relationship between output current and resistor value can be found at the table “Specific technical data”. Resistor values specified from standardised resistor value ranges. Resistor value tolerance has to be ≤ 1%. Resistor power has to be ≥ 0.1 W.

If the resistor is connected with wires a max. wire length of 2 m may not be exceeded and possible interferences have to be avoided.

Resistors for the main output current values can be ordered from Tridonic (see accessories).

Option 2: DALI

Adjustment is done by masterCONFIGURATOR (see masterCONFIGURATOR documentation).

Constant light output (CLO)

The luminous flux of an LED decreases constantly over the life-time. The CLO function ensures that the emitted luminous flux remains stable. For that purpose the LED current will increase continuously over the LED life-time. In masterCONFIGURATOR it is possible to select a start value (in percent) and an expected life-time. The LED Driver adjusts the current afterwards automatically.

Power-up fading

The power-up fading function offers the opportunity to realise a soft start. The soft start will be applied at turning on the mains and at starts by switchDIM.

The function is programmed as a DALI fade time in the range from 0.7 to 16 seconds and dims in the selected time from 0 % to the power-on level. By factory default power-up fading is not active (0 seconds).

Programming

With appropriate software and a USB interface different functions can be activated and various parameters can be configured in the LED Driver. All that is needed is a DALI-USB and the software (masterCONFIGURATOR).

masterCONFIGURATOR

From version 2.8:

For programming functions (CLO, I-select, power-up fading, corridorFUNCTION) and device settings (fade time, ePowerOnLevel, DC level, etc.). For further information see masterCONFIGURATOR manual.

Installation instructions

Input terminal and wiring

The wiring can be done by using stranded wires with end sleeves or with solid wires. A cross section of 0.5 - 1.5 mm² is required for mains wires. Strip 9,5 mm of the insulation from the cores to ensure perfect operation of the

push-wire terminals.

Use one wire for each terminal connector only.

Sheathed cable types NYM or J-Y(ST)Y with a diameter of 5.1 to 9.5 mm (max. value) can be used.

Use only one sheathed cable per strain relief.

wire preparation:

0.5 - 1.5 mm²



8.5 - 9.5 mm

Release of the wiring

Press down the “push button” and remove the cable from front.

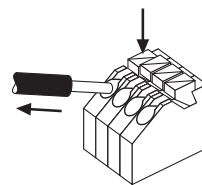

Side D2



max. Ø = 8,0 mm

min. Ø = 4,0 mm

Side D1



max. Ø = 4,8 mm

min. Ø = 2,2 mm

To get a proper working strain relief it is recommended that the cable jacket diameter of the side D2 is compared to the side D1 terminal according to the value table. (This can vary if the used cable jacket material varies from side D2 to D1 in pinching property).

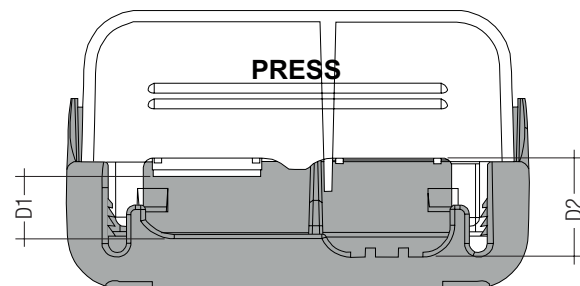

Depending on the used flaps of the terminal following cable jacket diameter difference between the side D2 and D1 terminals is recommended:

Side D1		Side D2		Difference D2 - D1		
Housing bottom	Cover terminal	With flap	Without flap			
With flap	Without flap	With flap	Without flap	With flap	Without flap	
x	-	x	-	x	-	3.5 mm
x	-	x	-	-	x	5.5 mm
x	-	-	x	-	x	3.5 mm
-	x	x	-	-	x	3.5 mm
-	x	-	x	-	x	1.5 mm
x	-	-	x	x	-	1.5 mm
-	x	x	-	x	-	1.5 mm
-	x	-	x	x	-	-0.5 mm

Output terminal

PCB plug socket from TE connectivity, type 293655-3
A suitable LED connection cable is separately available as detailed on page 3.

Matching part of the PCB plug socket consists of following parts from TE-connectivity:

- 2 x terminal , type 293390-1
- 1 x housing, type 293388-3
- 1 x housing, type 1740260-2

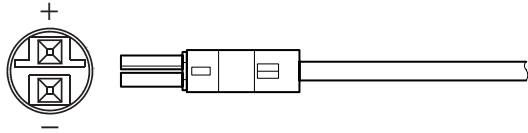

Wiring guidelines

- The cables should be run separately from the mains connections and mains cables to ensure good EMC conditions.
- The LED wiring should be kept as short as possible to ensure good EMC. The max. secondary cable length is 2 m (4 m circuit), this applies for LED output as well as for I-select.
- Secondary switching is not permitted.
- The LED Driver has no inverse-polarity protection on the secondary side. Wrong polarity can damage LED modules with no inverse-polarity protection.

Earth connection

The earth connection is conducted as protection earth (PE). If the LED Driver will be earthed, protection earth (PE) has to be used. There is no earth connection required for the functionality of the LED Driver. Earth connection is recommended to improve following behaviour.

- Electromagnetic interferences (EMI)
- LED glowing at stand-by
- Transmission of mains transients to the LED output

In general it is recommended to earth the LED Driver if the LED module is mounted on earthed luminaire parts respectively heat sinks and thereby representing a high capacity against earth.

Isolation and electric strength testing of luminaires

Electronic devices can be damaged by high voltage. This has to be considered during the routine testing of the luminaires in production.

According to IEC 60598-1 Annex Q (informative only!) or ENEC 303-Annex A, each luminaire should be submitted to an isolation test with 500 V_{DC} for 1 second. This test voltage should be connected between the interconnected phase and neutral terminals and the earth terminal. The isolation resistance must be at least 2 MΩ.

As an alternative, IEC 60598-1 Annex Q describes a test of the electrical strength with 1500 V_{AC} (or 1.414 x 1500 V_{DC}). To avoid damage to the electronic devices this test must not be conducted.

Additional information

Additional technical information at www.tridonic.com → Technical Data

Guarantee conditions at www.tridonic.com → Services

Life-time declarations are informative and represent no warranty claim. No warranty if device was opened.

Circuit diagram

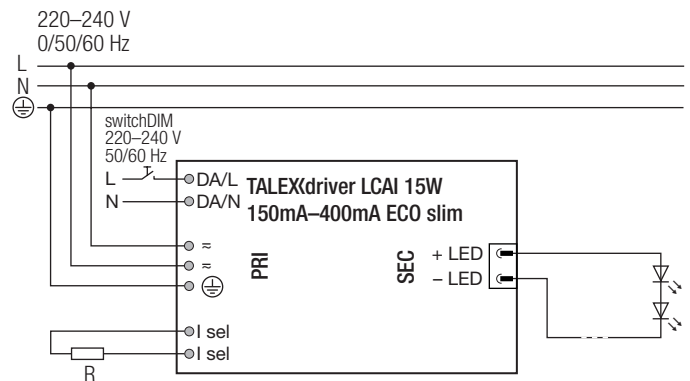
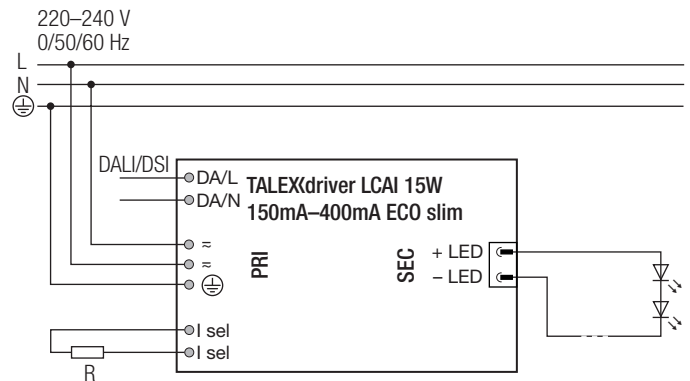

Diagrams LCAI 15W 150mA-400mA ECO slim

Efficiency vs load

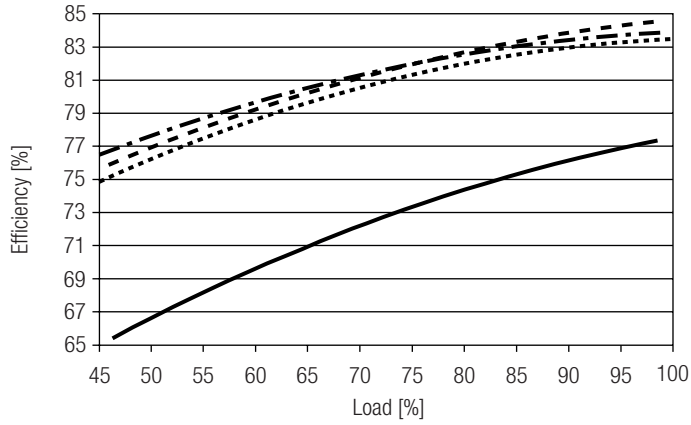

Power factor vs load

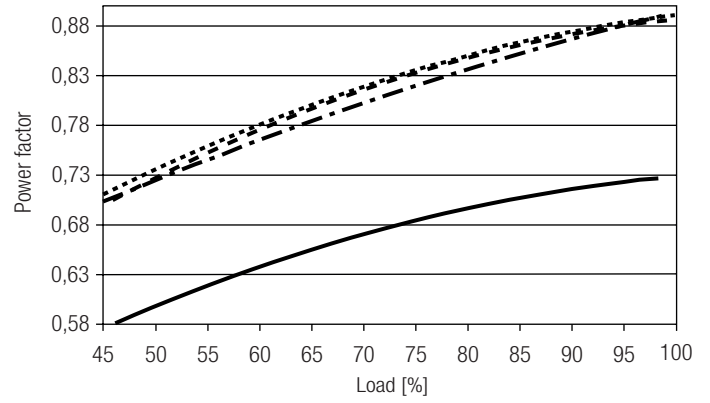

Input power vs load

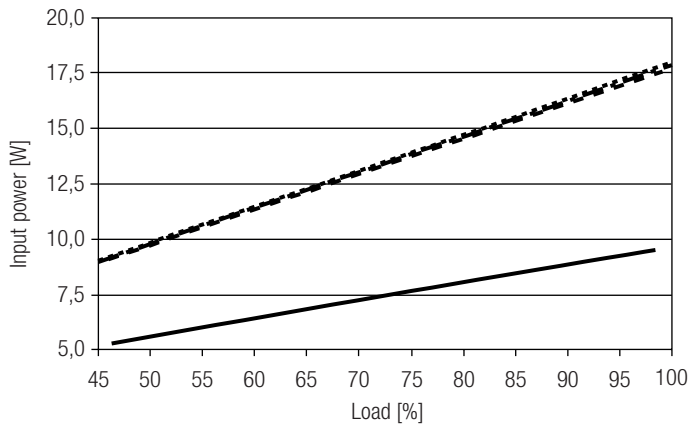

Input current vs load

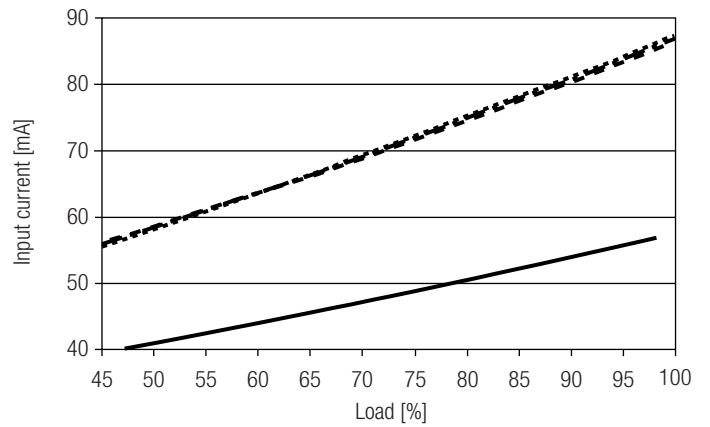

THD vs load

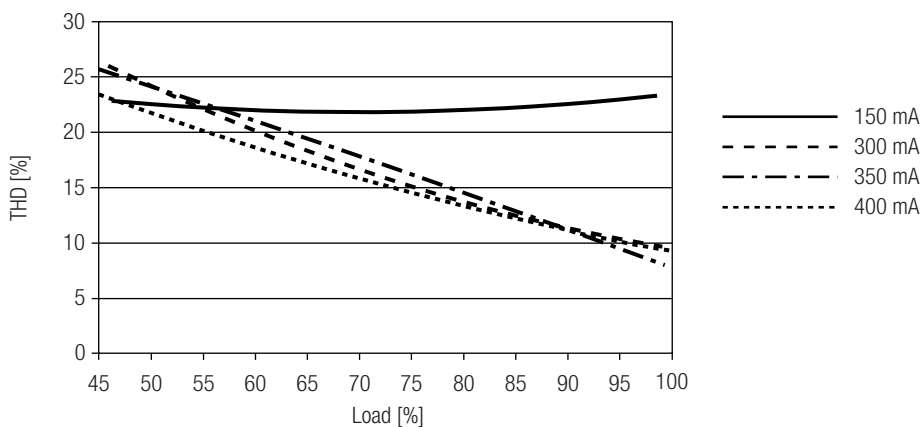

100 % load correspond to the max. output power (full load) according to the table on page 2.