

IP20 SELV             

Driver LCAI 20W 350mA–900mA ECO SR

ECO series

Product description

- Independent dimmable LED Driver
- Constant current LED Driver
- Output current adjustable between 350 – 900 mA
- Max. output power 20 W
- Nominal life-time up to 100,000 h
- 5-year guarantee
- Dimming range 1 ... 100 %

Properties

- Casing: polycarbonate, white
- Rapid installation of cable clamp and terminal cover, no tool required
- Large connection compartment
- Type of protection IP20

Interfaces

- DALI DEVICE Type 6
- DSI
- switchDIM (with memory function)
- corridorFUNCTION
- Input for temperature sensor (LED temperature monitoring)

Functions

- Adjustable output current (I-select resistor or DALI)
- Power-up fading at AC
- Intelligent Temperature Guard (overtemperature protection)
- Short-circuit proof
- Overload protection
- Constant Light Output function
- Suitable for emergency escape lighting systems acc. to EN50172

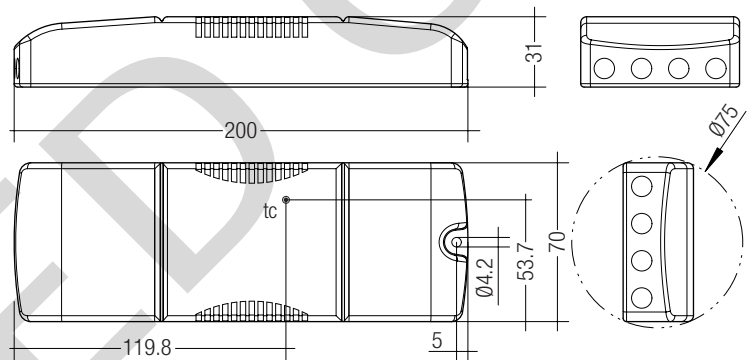

Ordering data

Type	Article number	Packaging carton	Packaging pallet	Weight per pc.
LCAI 20W 350mA-900mA ECO SR	28000123	10 pc(s).	400 pc(s).	0.2 kg



Standards, page 4

Technical data

Rated supply voltage	220 – 240 V
AC voltage range	198 – 264 V
DC voltage range	176 – 280 V
Mains frequency	0 / 50 / 60 Hz
Overvoltage protection	320 V AC, 48 h
Typ. current (at 230 V, 50 Hz, full load) ^①	88 – 105 mA
Typ. current (220 V, 0 Hz, full load, 15 % dimming level) ^②	22 – 26 mA
Leakage current (PE)	< 0.5 mA
Max. input power	25 W
Typ. efficiency (at 230 V / 50 Hz / full load) ^③	84 – 86 %
λ (at 230 V, 50 Hz, full load) ^④	> 0.96
Typ. power input on stand-by ^⑤	120 – 140 mW
THD (at 230 V, 50 Hz, full load)	< 20 %
Time to light (at 230 V, 50 Hz, full load, acc. to DALI)	< 0.6 s
Time to light (DC mode)	< 0.4 s
Switchover time (AC/DC)	< 0.4 s
Turn off time (at 230 V, 50 Hz, full load)	< 50 ms
Hold on time (at 230 V, 50 Hz, full load) ^⑥	15 ms
Output current tolerance ^⑦	± 3 %
Output LF current ripple (< 120 Hz)	< 2 %
Max. peak output current	≤ output current + 18 %
PWM frequency ^⑧	500 Hz
Dimming range	1 – 100 %
Max. output voltage	60 V
Burst / surge peaks output side against PE	< 500 V
Dimensions L x W x H	200 x 70 x 31 mm

Specific technical data

Type	Output current ^②	Min. forward voltage	Max. forward voltage ^③	Max. output power ^④	Typ. power consumption (at 230 V, 50 Hz, full load)	Typ. current consumption (at 230 V, 50 Hz, full load)	Max. casing temperature tc	Ambient temperature ta max.	I-select resistor value
	350 mA	22 V	50.0 V	17.5 W	20.3 W	88 mA	80 °C	-25 ... +60 °C	open
	375 mA	22 V	50.0 V	18.8 W	21.9 W	95 mA	80 °C	-25 ... +60 °C	71.50 kΩ
	400 mA	22 V	50.0 V	20.0 W	23.1 W	100 mA	80 °C	-25 ... +60 °C	66.50 kΩ
	425 mA	21 V	47.5 V	20.0 W	23.1 W	100 mA	80 °C	-25 ... +60 °C	61.90 kΩ
	450 mA	20 V	45.0 V	20.0 W	23.0 W	100 mA	80 °C	-25 ... +60 °C	57.60 kΩ
	475 mA	18 V	42.5 V	20.0 W	22.9 W	100 mA	80 °C	-25 ... +60 °C	53.60 kΩ
	500 mA	18 V	40.5 V	20.0 W	23.5 W	102 mA	75 °C	-25 ... +55 °C	49.90 kΩ
	525 mA	17 V	38.5 V	20.0 W	23.5 W	102 mA	75 °C	-25 ... +55 °C	45.30 kΩ
	550 mA	16 V	36.5 V	20.0 W	23.5 W	102 mA	75 °C	-25 ... +55 °C	42.20 kΩ
	575 mA	15 V	35.0 V	20.0 W	23.5 W	102 mA	75 °C	-25 ... +55 °C	38.30 kΩ
	600 mA	15 V	33.5 V	20.0 W	23.5 W	102 mA	75 °C	-25 ... +55 °C	35.70 kΩ
	625 mA	14 V	32.5 V	20.0 W	23.5 W	102 mA	75 °C	-25 ... +55 °C	32.40 kΩ
	650 mA	13 V	31.0 V	20.0 W	23.5 W	102 mA	75 °C	-25 ... +55 °C	28.70 kΩ
	675 mA	13 V	30.0 V	20.0 W	23.5 W	102 mA	75 °C	-25 ... +55 °C	26.10 kΩ
	700 mA	12 V	29.0 V	20.0 W	23.7 W	103 mA	75 °C	-25 ... +55 °C	22.00 kΩ
	725 mA	12 V	28.0 V	20.0 W	23.7 W	103 mA	75 °C	-25 ... +55 °C	17.40 kΩ
	750 mA	12 V	27.0 V	20.0 W	23.7 W	103 mA	75 °C	-25 ... +55 °C	15.00 kΩ
	775 mA	11 V	26.0 V	20.0 W	23.7 W	103 mA	75 °C	-25 ... +55 °C	12.40 kΩ
	800 mA	11 V	25.5 V	20.0 W	23.8 W	103 mA	75 °C	-25 ... +55 °C	10.00 kΩ
	825 mA	10 V	24.5 V	20.0 W	23.8 W	103 mA	75 °C	-25 ... +55 °C	7.68 kΩ
	850 mA	10 V	24.0 V	20.0 W	24.0 W	104 mA	75 °C	-25 ... +55 °C	5.36 kΩ
	875 mA	10 V	23.5 V	20.0 W	24.0 W	104 mA	75 °C	-25 ... +55 °C	3.16 kΩ
	900 mA	10 V	22.5 V	20.0 W	24.1 W	105 mA	75 °C	-25 ... +55 °C	short circuit (0 Ω)

- ① Valid at 100 % dimming level.
- ② Depending on the selected output current.
- ③ Depending on the DALI traffic at the interface.
- ④ At power failure.
- ⑤ ± 20 %.
- ⑥ At full load.
- ⑦ Output current is mean value.

Product description

- Ready-for-use resistor to set output current value
- Compatible with LED Driver series TOP and ECO
- Resistor is base isolated
- Resistor power 0.25 W
- Resistor value tolerance $\pm 1\%$

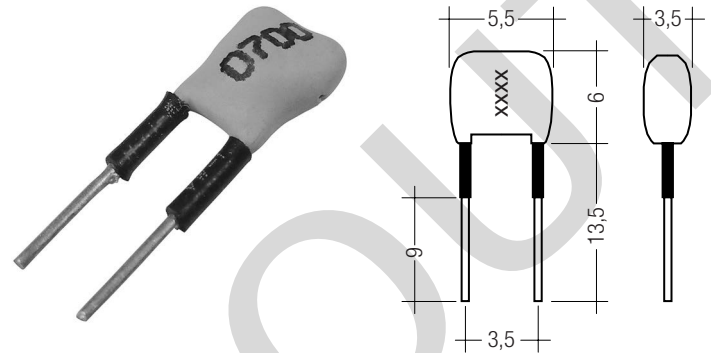

Ordering data

Type	Article number	Colour	Marking	Resistor value	Packaging bag	Weight per pc.
I-SELECT PLUG 400mA GN	28000451	Green	0400	66.50 k Ω	10 pc(s).	0.001 kg
I-SELECT PLUG 450mA GN	28000452	Green	0450	57.60 k Ω	10 pc(s).	0.001 kg
I-SELECT PLUG 500mA GN	28000277	Green	0500	4990 k Ω	10 pc(s).	0.001 kg
I-SELECT PLUG 550mA GN	28000453	Green	0550	42.20 k Ω	10 pc(s).	0.001 kg
I-SELECT PLUG 600mA GN	28000454	Green	0600	35.70 k Ω	10 pc(s).	0.001 kg
I-SELECT PLUG 650mA GN	28000455	Green	0650	28.70 k Ω	10 pc(s).	0.001 kg
I-SELECT PLUG 700mA GN	28000278	Green	0700	22.00 k Ω	10 pc(s).	0.001 kg
I-SELECT PLUG 750mA GN	28000456	Green	0750	15.00 k Ω	10 pc(s).	0.001 kg
I-SELECT PLUG 800mA GN	28000457	Green	0800	10.00 k Ω	10 pc(s).	0.001 kg
I-SELECT PLUG 850mA GN	28000458	Green	0850	5.36 k Ω	10 pc(s).	0.001 kg
I-SELECT PLUG MAX GR	28000274	Grey	MAX	0 Ω	10 pc(s).	0.001 kg

Standards

EN 55015
 EN 61000-3-2
 EN 61000-3-3
 EN 61347-1
 EN 61347-2-13
 EN 62384
 EN 61547
 EN 62386-101 (according to DALI standard V1)
 EN 62386-102
 EN 62386-207
 According to EN 50172 for use in central battery systems
 According to EN 60598-2-22 suitable for emergency lighting installations

Overload protection

If the output voltage range is exceeded the LED Driver turns off the LED output. After restart of the LED Driver the output will be activated again. The restart can either be done via mains reset or via interface (DALI, DSI, switchDIM).

Overtemperature protection

The LED Driver is protected against temporary thermal overheating. If the temperature limit is exceeded the output current of the LED is reduced. The temperature protection is activated approx. +5 °C above $t_{c\ max}$ (see page 2). On DC operation this function is deactivated to fulfill emergency requirements.

Short-circuit behaviour

In case of a short circuit at the LED output the LED output is switched off. After restart of the LED Driver the output will be activated again. The restart can either be done via mains reset or via interface (DALI, DSI, switchDIM).

No-load operation

The LED Driver will not be damaged in the no-load operation. The output will be deactivated and therefore free of voltage. If a LED load is connected the device has to be restarted before the output will be activated again.

Hot plug-in

Hot plug-in is not recommend within 5 s after shutdown due to output voltage of > 0 V. If a LED load is connected the device has to be restarted before the output will be activated again. This can be done with mains reset, DALI, DSI or switchDIM.

Conditions of use and storage

Humidity: 5% up to max. 85%, not condensed (max. 56 days/year at 85%)
 Storage temperature: -40 °C up to max. +80 °C

The devices have to be within the specified temperature range (t_a) before they can be operated.

Glow wire test

according to EN 61347-1 with increased temperature of 850 °C passed.

Expected life-time

Type	Output current	t_a	40 °C	50 °C	55 °C	60 °C
LCAI 20W 350mA-900mA ECO SR	≤ 500 mA	t_c	60 °C	70 °C	75 °C	80 °C
		Life-time	> 100,000 h	100,000 h	75,000 h	50,000 h
	> 500 mA	t_c	60 °C	70 °C	75 °C	80 °C
		Life-time	> 100,000 h	70,000 h	50,000 h	40,000 h

The LED Driver is designed for a life-time stated above under reference conditions and with a failure probability of less than 10 %.

Maximum loading of automatic circuit breakers

Automatic circuit breaker type	C10	C13	C16	C20	B10	B13	B16	B20	Inrush current	
Installation Ø	1.5 mm ²	1.5 mm ²	2.5 mm ²	2.5 mm ²	1.5 mm ²	1.5 mm ²	2.5 mm ²	2.5 mm ²	I_{max}	time
LCAI 20W 350mA-900mA ECO SR	60	80	100	140	60	80	100	140	5,75 A	40 µs

Harmonic distortion in the mains supply (at 230 V / 50 Hz and full load) in %

	THD	3.	5.	7.	9.	11.
LCAI 20W 350mA-900mA ECO SR	< 20	< 27	< 10	< 7	< 5	< 3

Control input (DA/N, DA/L)

Digital DALI signal or switchDIM can be wired on the same terminals (DA/N and DA/L).

Digital signal DALI/DSI

The control input is non-polar for digital control signals (DALI, DSI). The control signal is not SELV. Control cable has to be installed in accordance to the requirements of low voltage installations.

Different functions depending on each module.

switchDIM

Integrated switchDIM function allows a direct connection of a push to make switch for dimming and switching.

Brief push (< 0.6 s) switches LED Driver ON and OFF. The LED Drivers switch-ON at light level set at switch-OFF.

When the push to make switch is held, LED modules are dimmed. After repush the LED modules are dimmed in the opposite direction.

In installations with LED Drivers with different dimming levels or opposite dimming directions (e.g. after a system extension), all LED Drivers can be synchronized to 50 % dimming level by a 10 s push.

Use of push to make switch with indicator lamp is not permitted.

corridorFUNCTION

The corridorFUNCTION can be programmed in two different ways.

To program the corridorFUNCTION by means of software a DALI-USB interface is needed in combination with a DALI PS. The software can be the masterCONFIGURATOR.

To activate the corridorFUNCTION without using software a voltage of 230 V simply has to be applied for five minutes at the switchDIM connection.

The unit will then switch automatically to the corridorFUNCTION.

Note:

If the corridorFUNCTION is wrongly activated in a switchDIM system (for example a switch is used instead of pushbutton), there is the option of installing a pushbutton and deactivating the corridorFUNCTION mode by five short pushes of the button within three seconds.

switchDIM and corridorFUNCTION are very simple tools for controlling ballasts with conventional momentary-action switches or motion sensors.

To ensure correct operation a sinusoidal mains voltage with a frequency of 50 Hz or 60 Hz is required at the control input.

Special attention must be paid to achieving clear zero crossings. Serious mains faults may impair the operation of switchDIM and corridorFUNCTION.

Dimming

Dimming range 1 % to 100 %

Digital control with:

- DSI signal: 8 bit Manchester Code
Speed 1 % to 100 % in 1.4 s
- DALI signal: 16 bit Manchester Code
Speed 1 % to 100 % in 0.2 s
Programmable parameter:
Minimum dimming level
Maximum dimming level
Default minimum = 1 %
Programmable range $1\% \leq \text{MIN} \leq 100\%$
Default maximum = 100 %
Programmable range $100\% \geq \text{MAX} \geq 1\%$

Dimming curve is adapted to the eye sensitiveness.

Dimming is realized by a combination of analog amplitude dimming and PWM dimming.

35 ... 100 %: amplitude dimming

1 ... 34 %: PWM dimming

Dimming characteristics

Digital dimming value

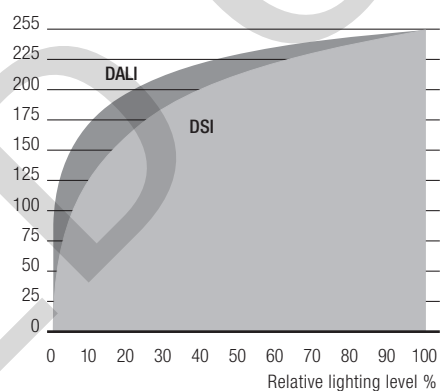

Dimming characteristics as seen by the human eye

DC emergency operation

The LED Driver is designed for operation on DC voltage and pulsed DC voltage.

Light output level programmable from 1 – 100 %
Programming by extended DSI or DALI signal (16 bit).
Default value is 15 %

In DC operation dimming mode can be activated.

The voltage-dependent input current of Driver incl. LED module is depending on the used load.

The voltage-dependent no-load current of Driver (without or defect LED module) is for:

AC: 7.6 mA

DC: 2.0 mA

Function: adjustable current (I-select)

The output current of the LED Driver can be selected between 350 and 900 mA. For adjustment there are two options available.

Option 1: „I-select resistor“

In 25 mA steps adjustable (see page 2, specific technical data, „I-select resistor value“).

Relationship between output current and resistor value can be found at the table “Specific technical data”. Resistor values specified from standardised resistor value ranges. Resistor value tolerance has to be $\leq 1\%$. Resistor power has to be ≥ 0.1 W.

If the resistor is connected with wires a max. wire length of 2 m may not be exceeded and possible interferences have to be avoided.

Resistors for the main output current values can be ordered from Tridonic (see accessories).

Option 2: DALI

Adjustment is done by masterCONFIGURATOR (see masterCONFIGURATOR documentation).

Constant light output (CLO)

The luminous flux of an LED decreases constantly over the life-time. The CLO function ensures that the emitted luminous flux remains stable. For that purpose the LED current will increase continuously over the LED life-time.

In masterCONFIGURATOR it is possible to select a start value (in percent) and an expected life-time. The LED Driver adjusts the current afterwards automatically.

Intelligent temperature monitoring (ITM)

The device offers the possibility to connect a silicon based temperature sensor (KTY81-210, KTY82-210) to monitor the LED temperature and protect the module against thermal damages.

If the temperature limit is exceeded the LED output will be dimmed or turned off. If the temperature falls below threshold the device will automatically return to the nominal operation.

The use of a NTC or PTC resistor is not possible.

The device can be operated without a sensor (default setting).

The function can be adjusted via masterCONFIGURATOR.

Power-up fading

The power-up fading function offers the opportunity to realise a soft start. The soft start will be applied at turning on the mains and at starts by switchDIM.

The function is programmed as a DALI fade time in the range from 0.7 to 16 seconds and dims in the selected time from 0 % to the power-on level. By factory default power-up fading is not active (0 seconds).

Programming

With appropriate software and a USB interface different functions can be activated and various parameters can be configured in the LED Driver. All that is needed is a DALI-USB and the software (masterCONFIGURATOR).

masterCONFIGURATOR

At version 2.8:

For programming functions (CLO, I-select, ITM, power-up fading, corridorFUNCTION) and device settings (fade time, ePowerOnLevel, DC level, etc.). For further information see masterCONFIGURATOR manual.

Installation instructions

Mains supply wires

Wiring type and cross section

Stranded wire or solid wire up to 2.5 mm² may be used for wiring. Strip 10–11 mm of insulation from the cables to ensure perfect operation of the push terminals.

Use one wire for each terminal connector only.

Use each strain relief channel for one cable only.

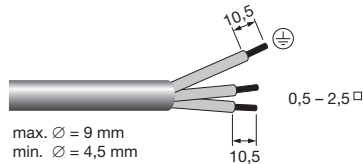

Secondary wires (LED module)

Wiring type and cross section

The wiring can be in stranded wires with ferrules or solid with a cross section of 0.2–1.5 mm².

Strip 8.5–9.5 mm of insulation from the cables to ensure perfect operation of the push-wire terminals.

Use one wire for each terminal connector only.

Use each strain relief channel for one cable only.

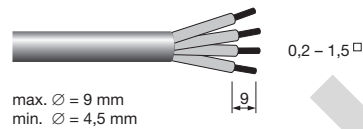

Fixing conditions

Dry, acidfree, oilfree, fatfree. It is not allowed to exceed the maximum ambient temperature (t_a) stated on the device. Minimum distances stated below are recommendations and depend on the actual luminaire. Is not suitable for fixing in corner.

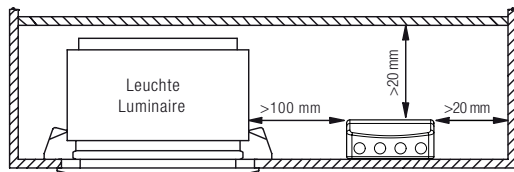

Isolation and electric strength testing of luminaires

Electronic devices can be damaged by high voltage. This has to be considered during the routine testing of the luminaires in production.

According to IEC 60598-1 Annex Q (informative only!) or ENEC 303-Annex A, each luminaire should be submitted to an isolation test with 500 V_{DC} for 1 second. This test voltage should be connected between the interconnected phase and neutral terminals and the earth terminal. The isolation resistance must be at least 2 MΩ.

As an alternative, IEC 60598-1 Annex Q describes a test of the electrical strength with 1500 V_{AC} (or 1.414 x 1500 V_{DC}). To avoid damage to the electronic devices this test must not be conducted.

Release of the wiring

Press down the "push button" and remove the cable from front.

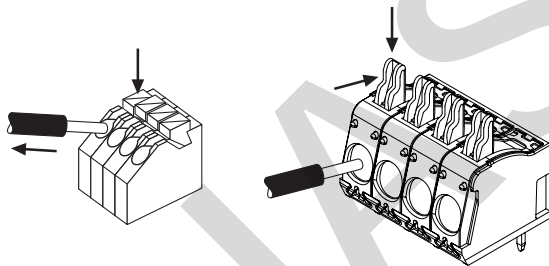

Wiring guidelines

- The cables should be run separately from the mains connections and mains cables to ensure good EMC conditions.
- The LED wiring should be kept as short as possible to ensure good EMC. The max. secondary cable length is 2 m (4 m circuit), this applies for LED output as well as for I-select and temperature sensor.
- The LED Driver has no inverse-polarity protection on the secondary side. Wrong polarity can damage LED modules with no inverse-polarity protection.
- Secondary switching is not permitted.
- The possibility to loop-through L, N, and PE of the input terminals is meant to wire several control gears in series. A maximum continuous current of 12 A must not be exceeded at the terminal.

Installation note

Max. torque at the clamping screw: 0.5 Nm / M4

Earth connection

The earth connection is conducted as protection earth (PE). If the LED Driver will be earthed, protection earth (PE) has to be used. There is no earth connection required for the functionality of the LED Driver. Earth connection is recommended to improve following behaviour.

- Electromagnetic interferences (EMI)
- LED glowing at stand-by
- Transmission of mains transients to the LED output

In general it is recommended to earth the LED Driver if the LED module is mounted on earthed luminaire parts respectively heat sinks and thereby representing a high capacity against earth.

Additional information

Additional technical information at www.tridonic.com → Technical Data

Guarantee conditions at www.tridonic.com → Services

Life-time declarations are informative and represent no warranty claim. No warranty if device was opened.

Circuit diagram

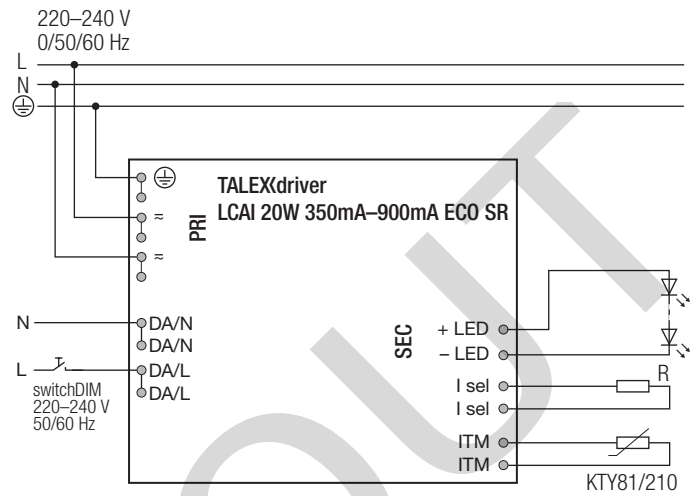
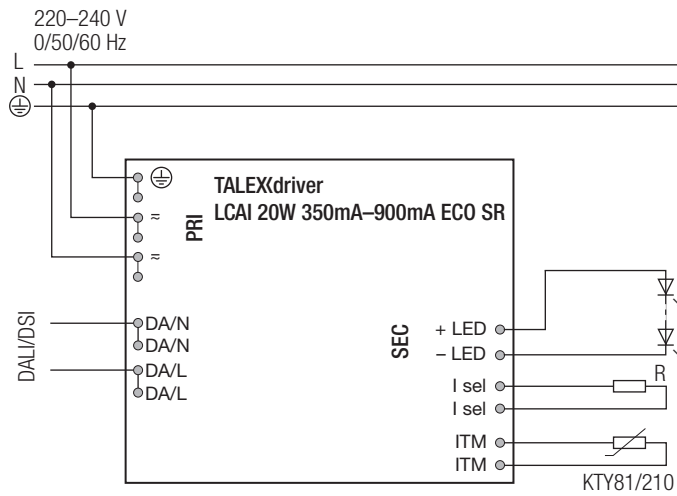

Diagrams LCAI 20W 350mA-900mA ECO SR

Efficiency vs load

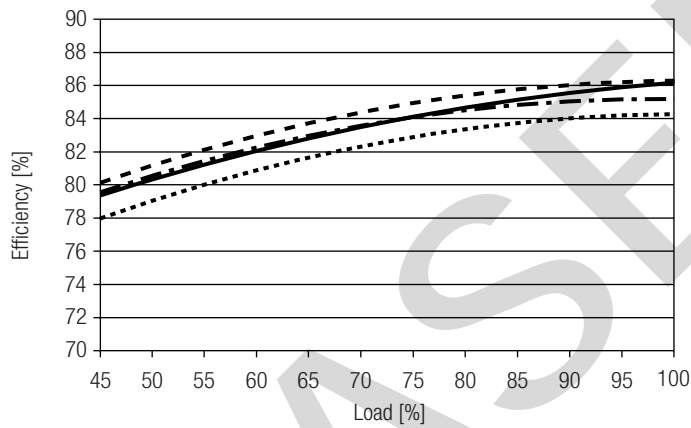

Power factor vs load

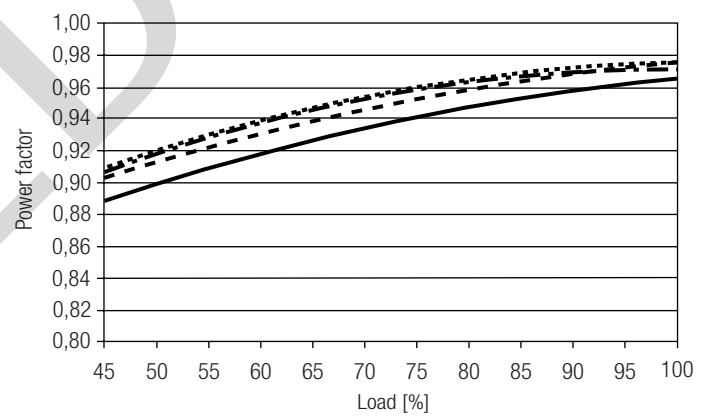

THD vs load

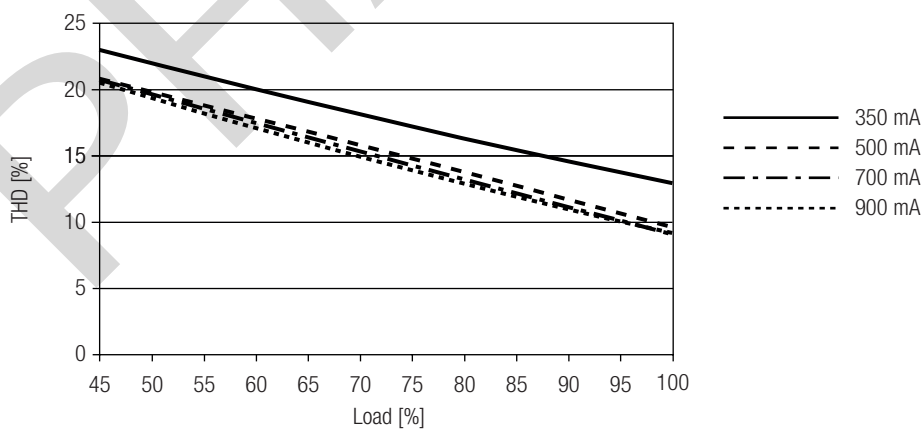

100 % load correspond to the max. output power (full load) according to the table on page 2.